

# HARDWARE

GROUNDING | WOOD/FIBERGLASS PRODUCTS

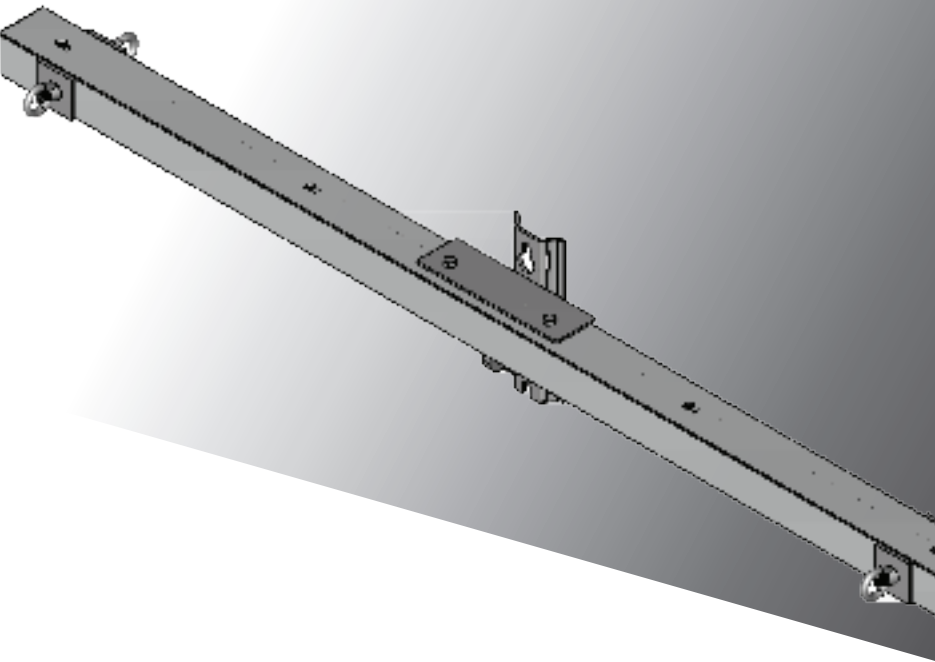

# RESCO

SUPPLYING THE COOPERATIVE ADVANTAGE



# TABLE OF CONTENTS

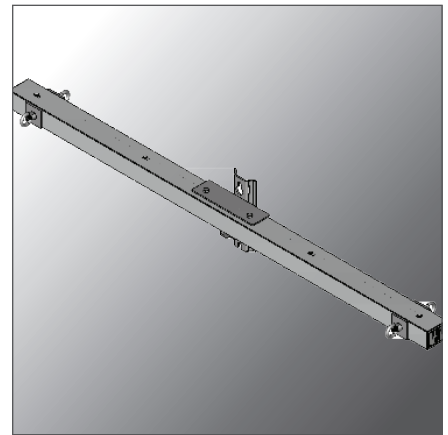



**Guy Hooks | Pole Eye Plates | Pole Bands..... 4 - 5**

**Carriage | Double Arming | Upset..... 5 - 9**  
**Ovaleye | Machine | Lag**

**Eyenuits | Square Nuts | Washers | Staples..... 9 - 12**

**Spool Clevis | Brackets..... 12 - 15**  
**Shield Wire Supports**

**Crossarm and Pole Top Insulator Pins..... 15 - 17**

**Clamps..... 17 - 22**

**Hardware..... 22 - 26**







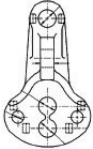

**Crossarms | Braces..... 27 - 28**

**Grounding..... 29 - 30**



# HARDWARE

IMAGE	RESCO PART #	DESCRIPTION	MFR MODEL #	MANUFACTURER	PACK. QTY.
	64001430HUGHES	Deadend Tee, 15/16" Mounting Holes, 60,000 lbs	2817-15	HUGHES BROTHERS	10
	02150100CHANCE	Angle Thimble Eyelets, 5/8" Bolt Diameter	0100	HUBBELL POWER SYSTEMS	50
	02150100JOSLYN	Angle Thimble Eyelets, 5/8" Bolt Diameter	J6500	MACLEAN POWER SYSTEMS	50
	02150100POWERLINEH	Angle Thimble Eyelets, 5/8" Bolt Diameter	P6500	POWER LINE HARDWARE LLC	50
	02150194CHANCE	Guy Hook Attachment, 5/8" Bolt Diameter	GH5	HUBBELL POWER SYSTEMS	25
	02150195CHANCE	Guy Hook Attachment, 3/4" Bolt Diameter	GH6	HUBBELL POWER SYSTEMS	50
	02150194JOSLYN	Guy Hook Attachment, 5/8" Bolt Diameter	P135A	MACLEAN POWER SYSTEMS	50
	02150209MACLEAN	Guy Hook Attachment	GAD-56-4	MACLEAN POWER SYSTEMS	50
	02150212MACLEAN	Universal Guy Hook Attachment, 7/16" Cable Diameter	UGA-65-3	MACLEAN POWER SYSTEMS	50
	02150215MACLEAN	Universal Guy Hook Attachment	MGA-345	MACLEAN POWER SYSTEMS	25

IMAGE	RESCO PART #	DESCRIPTION	MFR MODEL #	MANUFACTURER	PACK. QTY.
	02150216CHANCE	Pole Eye/Guy Hook Combination Attachment, 5/8" Bolt	GEP5	HUBBELL POWER SYSTEMS	25
	02150275CHANCE	Pole Eye/Guy Hook Combination Attachment, 3/4" Bolt	GEP5A	HUBBELL POWER SYSTEMS	25
	46800425MACLEAN	Pole Eye Plate, 3/4" Pin	PEP-66-45	MACLEAN POWER SYSTEMS	20
	02150300CHANCE	1-Bolt Storm Wrapped Pole Guy Hook	5004	HUBBELL POWER SYSTEMS	50
	02150345HUGHES	Pole Band, 4-Way, 90°, 7" - 10" Diameter	3105.5	HUGHES BROTHERS	2
	02150348HUGHES	Pole Band, 4-Way, 90°, 13" - 16" Diameter	3105.8	HUGHES BROTHERS	2
	02150426HUGHES	Heavy Duty Pole Band, 2-Way 180°, 10"-12" Diameter	3107.6	HUGHES BROTHERS	2
	02150427HUGHES	Heavy Duty Pole Band, 2-Way 180°, 12"-14" Diameter	3107.7	HUGHES BROTHERS	2
	64001410HUGHES	Heavy Duty Pole Band, 2-Way 180° 14" - 16" Diameter	3107.8	HUGHES BROTHERS	2
	02150429HUGHES	Heavy Duty Pole Band, 2-Way 180°, 16"-18" Diameter	3107.9	HUGHES BROTHERS	1
	02150430HUGHES	Heavy Duty Pole Band, 2-Way 180°, 18"-20" Diameter	3107.10	HUGHES BROTHERS	1
	02150445HUGHES	Heavy Duty Pole Band, 2-Way 180°, 7"-10" Diameter	3108.5	HUGHES BROTHERS	2
	02150446HUGHES	Heavy Duty Pole Band, 2-Way 180°, 9"-12" Diameter	3108.6	HUGHES BROTHERS	2
	02150447HUGHES	Heavy Duty Pole Band, 2-Way 180°, 11"-14" Diameter	3108.7	HUGHES BROTHERS	2
02150448HUGHES	Heavy Duty Pole Band, 2-Way 180°, 13"-16" Diameter	3108.8	HUGHES BROTHERS	1	
	34272040HUGHES	Connecting Link 3/8" x 2" x 9-1/2"	3154	HUGHES BROTHERS	30
	34273151HUGHES	Connecting Link 1/4" x 3" x 9-1/2"	3151	HUGHES BROTHERS	30
	34273152HUGHES	Connecting Link 1/4" x 2" x 9-1/2"	3152	HUGHES BROTHERS	40
	71012850HUGHES	Connecting Link 1/4" x 3" x 9-1/2"	3153	HUGHES BROTHERS	1
	34273157HUGHES	Connecting Link 3/8" x 3" x 12"	3157	HUGHES BROTHERS	10
	06310345CHANCE	Carriage Bolt, 3/8" x 4-1/2"	8634 1/2	HUBBELL POWER SYSTEMS	250
	06310345JOSLYN	Carriage Bolt, 3/8" x 4-1/2"	J8634.5	MACLEAN POWER SYSTEMS	250
	06310305CHANCE	Carriage Bolt, 3/8" x 5"	8635	HUBBELL POWER SYSTEMS	250
	06310310CHANCE	Carriage Bolt, 3/8" x 6"	8636	HUBBELL POWER SYSTEMS	250
	06310406CHANCE	Carriage Bolt, 1/2" x 6"	8646	HUBBELL POWER SYSTEMS	100
	06330660CHANCE	Double-Ended Bolt, 7/8" x 24"	PSDE782400	HUBBELL POWER SYSTEMS	10
	06330514CHANCE	Double-Arming Bolt, 5/8" x 14"	8864	HUBBELL POWER SYSTEMS	20
	06330516CHANCE	Double-Arming Bolt, 5/8" x 16"	8866	HUBBELL POWER SYSTEMS	20
	06330518CHANCE	Double-Arming Bolt, 5/8" x 18"	8868	HUBBELL POWER SYSTEMS	20
	06330518JOSLYN	Double-Arming Bolt, 5/8" x 18"	J8868	MACLEAN POWER SYSTEMS	25
	06330520CHANCE	Double-Arming Bolt, 5/8" x 20"	8870	HUBBELL POWER SYSTEMS	20
	06330520JOSLYN	Double-Arming Bolt, 5/8" x 20"	J8870	MACLEAN POWER SYSTEMS	25
	06330522CHANCE	Double-Arming Bolt, 5/8" x 22"	8872	HUBBELL POWER SYSTEMS	20
	06330522JOSLYN	Double-Arming Bolt, 5/8" x 22"	J8872	MACLEAN POWER SYSTEMS	25

Madison, WI

Mt. Pleasant, MI

Williston, ND

Kearney, NE

Moorhead, MN

Elkhart, IA

Pierre, SD

# HARDWARE













IMAGE	RESCO PART #	DESCRIPTION	MFR MODEL #	MANUFACTURER	PACK. QTY.
	06330524CHANCE	Double-Arming Bolt, 5/8" x 24"	8874	HUBBELL POWER SYSTEMS	20
	06330524JOSLYN	Double-Arming Bolt, 5/8" x 24"	J8874	MACLEAN POWER SYSTEMS	25
	06330526CHANCE	Double-Arming Bolt, 5/8" x 26"	8876	HUBBELL POWER SYSTEMS	20
	06330532CHANCE	Double-Arming Bolt, 5/8" x 32"	8879	HUBBELL POWER SYSTEMS	15
	06330535JOSLYN	Double-Arming Bolt, 5/8" x 34"	J8880	MACLEAN POWER SYSTEMS	10
	06330616CHANCE	Double-Arming Bolt, 3/4" x 16"	8886	HUBBELL POWER SYSTEMS	15
	06330620CHANCE	Double-Arming Bolt, 3/4" x 20"	8890	HUBBELL POWER SYSTEMS	15
	06330622CHANCE	Double-Arming Bolt, 3/4" x 22"	8892	HUBBELL POWER SYSTEMS	15
	06330624CHANCE	Double-Arming Bolt, 3/4" x 24"	8894	HUBBELL POWER SYSTEMS	15
	06330626CHANCE	Double-Arming Bolt, 3/4" x 26"	8896	HUBBELL POWER SYSTEMS	15
	06330628CHANCE	Double-Arming Bolt, 3/4" x 28"	8897	HUBBELL POWER SYSTEMS	15
	06330630CHANCE	Double-Arming Bolt, 3/4" x 30"	8898	HUBBELL POWER SYSTEMS	10
	06330745JOSLYN	Double-Arming Bolt, 3/4" x 34"	J9003	MACLEAN POWER SYSTEMS	10
	06330722CHANCE	Double-Arming Bolt, 7/8" x 22"	PSDA782200	HUBBELL POWER SYSTEMS	10
	06330724CHANCE	Double-Arming Bolt, 7/8" x 24"	PSDA782400	HUBBELL POWER SYSTEMS	10
	06330655CHANCE	Double-Arming Bolt, 7/8" x 26"	PSDA782600	HUBBELL POWER SYSTEMS	10
	06330723CHANCE	Double-Arming Bolt, 7/8" x 28"	PSDA782800	HUBBELL POWER SYSTEMS	10
	06330732CHANCE	Double-Arming Bolt, 7/8" x 32"	PSDA783200	HUBBELL POWER SYSTEMS	10
06330734JOSLYN	Double-Arming Bolt, 7/8" x 34"	J9134	MACLEAN POWER SYSTEMS	5	
	06390508CHANCE	Single-Upset Spool Bolt, 5/8" x 8"	7741	HUBBELL POWER SYSTEMS	25
	06390509CHANCE	Single-Upset Spool Bolt, 5/8" x 9"	7741 1/2	HUBBELL POWER SYSTEMS	25
	06390510CHANCE	Single-Upset Spool Bolt, 5/8" x 10"	7742	HUBBELL POWER SYSTEMS	25
	06390510JOSLYN	Single-Upset Spool Bolt, 5/8" x 10" (Spool Insulator Separate)	J2344 1/2	MACLEAN POWER SYSTEMS	25
	06390512CHANCE	Single-Upset Spool Bolt, 5/8" x 12"	7743	HUBBELL POWER SYSTEMS	25
	06350510CHANCE	Double-Upset Spool Bolt, 5/8" x 10"	7830	HUBBELL POWER SYSTEMS	30
	06350510JOSLYN	Double-Upset Spool Bolt, 5/8" x 10" (Spool Insulator Separate)	J2396	MACLEAN POWER SYSTEMS	25
	06350510ALLIED	Double-Upset Spool Bolt, 5/8" x 10"	1717	ALLIED BOLT INC.	1
	06350512CHANCE	Double-Upset Spool Bolt, 5/8" x 12"	7832	HUBBELL POWER SYSTEMS	25
	06350514CHANCE	Double-Upset Spool Bolt, 5/8" x 14"	7834	HUBBELL POWER SYSTEMS	20

IMAGE	RESCO PART #	DESCRIPTION	MFR MODEL #	MANUFACTURER	PACK. QTY.
	06360610HUGHES	Shoulder Eyebolt, 5/8" Diameter, 10" Length, 4" Thread Length	2720.610-4	HUGHES BROTHERS	20
	06360522HUGHES	Shoulder Eyebolt, 5/8" Diameter, 22" Length, 4" Thread Length	2720.622-6	HUGHES BROTHERS	1
	06360620HUGHES	Shoulder Eyebolt, 3/4" Diameter, 10" Length, 4" Thread Length	2720.710-4	HUGHES BROTHERS	20
	06360622HUGHES	Shoulder Eyebolt, 3/4" Diameter, 22" Length, 6" Thread Length	2720.722-6	HUGHES BROTHERS	10
	06361406CHANCE	Screw Eye Bolt, 1/2" Diameter x 6" Thread Length	29930	HUBBELL POWER SYSTEMS	50
	06361508CHANCE	Ovaleye Bolt, 5/8" x 8"	29958	HUBBELL POWER SYSTEMS	35
	06361508JOSLYN	Ovaleye Bolt, 5/8" x 8"	J9408	MACLEAN POWER SYSTEMS	25
	06361509CHANCE	Ovaleye Bolt, 5/8" x 9"	29959	HUBBELL POWER SYSTEMS	25
	06361509JOSLYN	Ovaleye Bolt, 5/8" x 9"	J9409	MACLEAN POWER SYSTEMS	25
	06361510CHANCE	Ovaleye Bolt, 5/8" x 10"	29960	HUBBELL POWER SYSTEMS	25
	06361510JOSLYN	Ovaleye Bolt, 5/8" x 10"	J9410	MACLEAN POWER SYSTEMS	25
	06361512CHANCE	Ovaleye Bolt, 5/8" x 12"	29962	HUBBELL POWER SYSTEMS	25
	06361512JOSLYN	Ovaleye Bolt, 5/8" x 12"	J9412	MACLEAN POWER SYSTEMS	25
	06361514CHANCE	Ovaleye Bolt, 5/8" x 14"	29964	HUBBELL POWER SYSTEMS	25
	06361516CHANCE	Ovaleye Bolt, 5/8" x 16"	29966	HUBBELL POWER SYSTEMS	25
	06361518CHANCE	Ovaleye Bolt, 5/8" x 18"	29968	HUBBELL POWER SYSTEMS	25
	06361522CHANCE	Ovaleye Bolt, 5/8" x 22"	29972	HUBBELL POWER SYSTEMS	40
	06361612CHANCE	Ovaleye Bolt, 3/4" x 12"	29982	HUBBELL POWER SYSTEMS	20
	06361614CHANCE	Ovaleye Bolt, 3/4" x 14"	29984	HUBBELL POWER SYSTEMS	20
	06365510CHANCE	Thimbleye Bolt, 5/8" x 10"	5510	HUBBELL POWER SYSTEMS	25
	06365510JOSLYN	Thimbleye Bolt, 5/8" x 10"	J8051	MACLEAN POWER SYSTEMS	25
	06365512CHANCE	Thimbleye Bolt, 5/8" x 12"	5512	HUBBELL POWER SYSTEMS	25
	06363412CHANCE	Thimbleye Bolt, 3/4" x 12"	5612	HUBBELL POWER SYSTEMS	15
	06380415CHANCE	Machine Bolt, 1/2" x 1-1/2"	870112	HUBBELL POWER SYSTEMS	250
	06380405CHANCE	Machine Bolt, 1/2" x 5"	8705	HUBBELL POWER SYSTEMS	100
	06380406CHANCE	Machine Bolt, 1/2" x 6"	8706	HUBBELL POWER SYSTEMS	100
	06380406JOSLYN	Machine Bolt, 1/2" x 6"	J8706	MACLEAN POWER SYSTEMS	100
	06380407CHANCE	Machine Bolt, 1/2" x 7"	8707	HUBBELL POWER SYSTEMS	100
	06380408CHANCE	Machine Bolt, 1/2" x 8"	8708	HUBBELL POWER SYSTEMS	100
	06380410CHANCE	Machine Bolt, 1/2" x 10"	8710	HUBBELL POWER SYSTEMS	100
	06380505CHANCE	Machine Bolt, 5/8" x 5"	8805	HUBBELL POWER SYSTEMS	50
	06380505JOSLYN	Machine Bolt, 5/8" x 5"	J8805	MACLEAN POWER SYSTEMS	50
	06380506CHANCE	Machine Bolt, 5/8" x 6"	8806	HUBBELL POWER SYSTEMS	50
	06380506JOSLYN	Machine Bolt, 5/8" x 6"	J8806	MACLEAN POWER SYSTEMS	50
	06380506POWERLINEHWD	Machine Bolt, 5/8" x 6"	P8806	POWER LINE HARDWARE LLC	50
	06380508CHANCE	Machine Bolt, 5/8" x 8"	8808	HUBBELL POWER SYSTEMS	50
	06380508JOSLYN	Machine Bolt, 5/8" x 8"	J8808	MACLEAN POWER SYSTEMS	50
	06380509CHANCE	Machine Bolt, 5/8" x 9"	8809	HUBBELL POWER SYSTEMS	50
	06380509JOSLYN	Machine Bolt, 5/8" x 9"	J8809	MACLEAN POWER SYSTEMS	50
	06380510CHANCE	Machine Bolt, 5/8" x 10"	8810	HUBBELL POWER SYSTEMS	50
	06380510JOSLYN	Machine Bolt, 5/8" x 10"	J8810	MACLEAN POWER SYSTEMS	50
	06380512CHANCE	Machine Bolt, 5/8" x 12"	8812	HUBBELL POWER SYSTEMS	50

Madison, WI

Mt. Pleasant, MI

Williston, ND

Kearney, NE

Moorhead, MN

Elkhart, IA

Pierre, SD

# HARDWARE













IMAGE	RESCO PART #	DESCRIPTION	MFR MODEL #	MANUFACTURER	PACK. QTY.
	06380514CHANCE	Machine Bolt, 5/8" x 14"	8814	HUBBELL POWER SYSTEMS	50
	06380514JOSLYN	Machine Bolt, 5/8" x 14"	J8814	MACLEAN POWER SYSTEMS	25
	06380516CHANCE	Machine Bolt, 5/8" x 16"	8816	HUBBELL POWER SYSTEMS	30
	06380516JOSLYN	Machine Bolt, 5/8" x 16"	J8816	MACLEAN POWER SYSTEMS	25
	06380518CHANCE	Machine Bolt, 5/8" x 18"	8818	HUBBELL POWER SYSTEMS	30
	06380520CHANCE	Machine Bolt, 5/8" x 20"	8820	HUBBELL POWER SYSTEMS	30
	06380522CHANCE	Machine Bolt, 5/8" x 22"	8822	HUBBELL POWER SYSTEMS	25
	06380524CHANCE	Machine Bolt, 5/8" x 24"	8824	HUBBELL POWER SYSTEMS	25
	06380526JOSLYN	Machine Bolt, 5/8" x 26"	J8826	MACLEAN POWER SYSTEMS	25
	06380528CHANCE	Machine Bolt, 5/8" x 28"	8828	HUBBELL POWER SYSTEMS	25
	06380610CHANCE	Machine Bolt, 3/4" x 10"	8910	HUBBELL POWER SYSTEMS	30
	06380610POWERLINEH	Machine Bolt, 3/4" x 10"	P8910	POWER LINE HARDWARE LLC	25
	06380612CHANCE	Machine Bolt, 3/4" x 12"	8912	HUBBELL POWER SYSTEMS	25
	06380612JOSLYN	Machine Bolt, 3/4" x 12"	J8912	MACLEAN POWER SYSTEMS	25
	06380614CHANCE	Machine Bolt, 3/4" x 14"	8914	HUBBELL POWER SYSTEMS	25
	06380614JOSLYN	Machine Bolt, 3/4" x 14"	J8914	MACLEAN POWER SYSTEMS	25
	06380616CHANCE	Machine Bolt, 3/4" x 16"	8916	HUBBELL POWER SYSTEMS	25
	06380618CHANCE	Machine Bolt, 3/4" x 18"	8918	HUBBELL POWER SYSTEMS	25
	06380620CHANCE	Machine Bolt, 3/4" x 20"	8920	HUBBELL POWER SYSTEMS	25
	06380622CHANCE	Machine Bolt, 3/4" x 22"	8922	HUBBELL POWER SYSTEMS	15
	06380624CHANCE	Machine Bolt, 3/4" x 24"	8924	HUBBELL POWER SYSTEMS	15
	06380626CHANCE	Machine Bolt, 3/4" x 26"	8926	HUBBELL POWER SYSTEMS	15
	06380628CHANCE	Machine Bolt, 3/4" x 28"	8928	HUBBELL POWER SYSTEMS	15
	06380703HUGHES	Machine Bolt, 7/8" x 3"	B83-2	HUGHES BROTHERS	50
	06380704HUGHES	Machine Bolt, 7/8" x 4"	B84-2	HUGHES BROTHERS	50
	06380708CHANCE	Machine Bolt, 7/8" x 8"	PSSB780800	HUBBELL POWER SYSTEMS	30
	06380712CHANCE	Machine Bolt, 7/8" x 12"	DF5B12	HUBBELL POWER SYSTEMS	25
	06380714CHANCE	Machine Bolt, 7/8" x 14"	C205-0254	HUBBELL POWER SYSTEMS	15
	06380716CHANCE	Machine Bolt, 7/8" x 16"	C205-0255	HUBBELL POWER SYSTEMS	15
	06380718CHANCE	Machine Bolt, 7/8" x 18"	C205-0256	HUBBELL POWER SYSTEMS	15
	06380720CHANCE	Machine Bolt, 7/8" x 20"	C2050257	HUBBELL POWER SYSTEMS	10
	06380722CHANCE	Machine Bolt, 7/8" x 22"	C2050258	HUBBELL POWER SYSTEMS	10
	06380724CHANCE	Machine Bolt, 7/8" x 24"	DF5B24	HUBBELL POWER SYSTEMS	10
	06380726CHANCE	Machine Bolt, 7/8" x 26"	PSSB782600	HUBBELL POWER SYSTEMS	10
	06380728CHANCE	Machine Bolt, 7/8" x 28"	PSSB782800	HUBBELL POWER SYSTEMS	10
	06380732CHANCE	Machine Bolt, 7/8" x 32"	PSSB783200	HUBBELL POWER SYSTEMS	5
	06380734CHANCE	Machine Bolt, 7/8" x 34"	PSSB783400	HUBBELL POWER SYSTEMS	5
	06380738CHANCE	Machine Bolt, 7/8" x 38"	PSSB783800	HUBBELL POWER SYSTEMS	10
	06381003HUGHES	Machine Bolt, 1" x 3"	B103-2	HUGHES BROTHERS	40
	06381004HUGHES	Machine Bolt, 1" x 4"	B104-2-3/4	HUGHES BROTHERS	40
06381005HUGHES	Machine Bolt, 1" x 5"	B105-3	HUGHES BROTHERS	30	



IMAGE	RESCO PART #	DESCRIPTION	MFR MODEL #	MANUFACTURER	PACK. QTY.
	06400059HUGHES	Washer Head Bolt, 1/2" X 9"	WB59-4	HUGHES BROTHERS	50
	06400510HUGHES	Washer Head Bolt, 1/2" X 10"	WB510-4	HUGHES BROTHERS	50
	55504007PREMAX	Galvanized Steel Nail, 1"	BGN-15-BP	PREMAX LLC	1
	55504000EM	Lag Screw, 1/4" x 2", Rub Washer	106M	ELECTRICAL MATERIALS CO	2000
	55504333CHANCE	Fetter Drive Pilot-Point Lag Screw, 3/8" x 3"	508743	HUBBELL POWER SYSTEMS	500
	55504440CHANCE	Fetter Drive Pilot-Point Lag Screw, 1/2" x 4"	508754	HUBBELL POWER SYSTEMS	250
	55504440JOSLYN	Fetter Drive Pilot-Point Lag Screw, 1/2" x 4"	J8754P	MACLEAN POWER SYSTEMS	250
	55504447CHANCE	Twist Drive Pilot-Point Lag Screw, 1/2" x 4"	508500	HUBBELL POWER SYSTEMS	250
	55504447JOSLYN	Twist Drive Pilot-Point Lag Screw, 1/2" x 4"	J8754TP	MACLEAN POWER SYSTEMS	250
	55504450HUGHES	Gimlet Point Lag Screw, 1/2" x 5"	LS55	HUGHES BROTHERS	1
	55504460HUGHES	Gimlet Point Lag Screw, 5/8" x 5"	LS65	HUGHES BROTHERS	1
	78722900CMC	Stainless Steel Bolt Assembly, 1-1/2"	SBA15-50	CONNECTOR MANUFACTURING	100
	78722901CMC	Stainless Steel Bolt Assembly, 1-3/4"	SBA17-50	CONNECTOR MANUFACTURING	10
	78722902CMC	Stainless Steel Bolt Assembly, 2"	SBA20-50	CONNECTOR MANUFACTURING	10
	42901063CHANCE	Standard Eyenut, 5/8" Diameter Bolt	6502	HUBBELL POWER SYSTEMS	75
	42901063LINEHRDW	Standard Eyenut, 5/8" Diameter Bolt	OEN-58	LINE HARDWARE INC.	100
	42901075CHANCE	Standard Eyenut, 3/4" Diameter Bolt	6503	HUBBELL POWER SYSTEMS	75
	06364014CHANCE	Ovaleye Eyelet, 5/8"	B14A	HUBBELL POWER SYSTEMS	40
	42906063CHANCE	Threaded Thimbleye®, 5/8" Bolt	6510	HUBBELL POWER SYSTEMS	50
	42906063JOSLYN	Thimbleye Eyenut, 5/8" Bolt	J6510	MACLEAN POWER SYSTEMS	50
	42906064CHANCE	Threaded Thimbleye®, 3/4" Bolt	6511	HUBBELL POWER SYSTEMS	50

Madison, WI

Mt. Pleasant, MI

Williston, ND

Kearney, NE









Moorhead, MN

Elkhart, IA

Pierre, SD

# HARDWARE

IMAGE	RESCO PART #	DESCRIPTION	MFR MODEL #	MANUFACTURER	PACK. QTY.
	42901463CHANCE	Square Nut, 5/8"	55084P	HUBBELL POWER SYSTEMS	250
	42901475CHANCE	Square Nut, 3/4"	55085P	HUBBELL POWER SYSTEMS	250
	42901475HUGHES	Square Nut, 3/4"	N70	HUGHES BROTHERS	400
	42901478CHANCE	Square Nut, 7/8"	56538P	HUBBELL POWER SYSTEMS	100
	42901478HUGHES	Square Nut, 7/8"	N80	HUGHES BROTHERS	100
	42901480HUGHES	Square Nut, 1"	N100	HUGHES BROTHERS	150
	42903010HUGHES	Square Locknut, 1"	MF100	HUGHES BROTHERS	400
	42903038CHANCE	Type MF Curved Locknut, 3/8"	3510	HUBBELL POWER SYSTEMS	1000
	42903050CHANCE	Type MF Curved Locknut, 1/2"	3511	HUBBELL POWER SYSTEMS	2000
	42903050JOSLYN	Type MF Curved Locknut, 1/2"	J8582	MACLEAN POWER SYSTEMS	1500
	42903063CHANCE	Type MF Curved Locknut, 5/8"	3512	HUBBELL POWER SYSTEMS	1250
	42903063JOSLYN	Type MF Curved Locknut, 5/8"	J8583	MACLEAN POWER SYSTEMS	800
	42903075CHANCE	Type MF Curved Locknut, 3/4"	3513	HUBBELL POWER SYSTEMS	1000
	42903087CHANCE	Type MF Curved Locknut, 7/8"	3514	HUBBELL POWER SYSTEMS	750
	71012745CHANCE	Washer Nut, 1/2" x 2"	3193	HUBBELL POWER SYSTEMS	100
	71012745HUGHES	Washer Nut, 1/2" x 3"	2745.5	HUGHES BROTHERS	200
	71012800CHANCE	Washer Nut, 3/4" x 2-3/4"	3195	HUBBELL POWER SYSTEMS	100
	71012800HUGHES	Washer Nut, 3/4" x 3"	2745.7	HUGHES BROTHERS	100
	71020131CHANCE	Flat Square Washer, 2" x 2" x 1/8", 1/2" Bolt	6811	HUBBELL POWER SYSTEMS	300
	71020141CHANCE	Flat Square Washer, 2" x 2" x 1/8", 5/8" Bolt	6812	HUBBELL POWER SYSTEMS	300
	71020460HUGHES	Flat Square Washer, 2" x 2" x 1/4", 3/4" Bolt	SW2-70	HUGHES BROTHERS	150
	71020448HUGHES	Flat Square Washer, 2-1/4" x 2-1/4" x 1/4", 1/2" Bolt	SW2-1/4-50	HUGHES BROTHERS	150
	71020441CHANCE	Flat Square Washer, 2-1/4" x 2-1/4" x 3/16", 5/8" Bolt	6813	HUBBELL POWER SYSTEMS	200
	71020441JOSLYN	Flat Square Washer, 2-1/4" x 2-1/4" x 3/16", 5/8" Bolt	J1075	MACLEAN POWER SYSTEMS	250
	71020451CHANCE	Flat Square Washer, 2-1/4" x 2-1/4" x 3/16", 3/4" Bolt	6814	HUBBELL POWER SYSTEMS	200
	71021451CHANCE	Flat Square Washer, 3" x 3" x 1/4", 3/4" Bolt	6817	HUBBELL POWER SYSTEMS	50
	71014030HUGHES	Flat Square Washer, 4" x 4" x 1/4", 5/8" Bolt	SW4-60	HUGHES BROTHERS	50
	71022861CHANCE	Flat Square Washer, 4" x 4" x 3/16", 3/4" Bolt	6818	HUBBELL POWER SYSTEMS	50
	71014051CHANCE	Flat Square Washer, 4" x 4" x 1/4", 3/4" Bolt	681812	HUBBELL POWER SYSTEMS	25

IMAGE	RESCO PART #	DESCRIPTION	MFR MODEL #	MANUFACTURER	PACK. QTY.
	71014051HUGHES	Flat Square Washer, 4" x 4" x 1/4", 3/4" Bolt	SW4-70	HUGHES BROTHERS	50
	71023061CHANCE	Flat Square Washer, 4" x 4" x 1/4", 7/8" Bolt	6819	HUBBELL POWER SYSTEMS	25
	71023061MACLEAN	Flat Square Washer, 4" x 4" x 1/4", 3/4" & 7/8" Bolt	J1082	MACLEAN POWER SYSTEMS	50
	71023652CHANCE	Curved Square Washer, 2-1/2" x 2-1/2" x 3/16", 5/8" Bolt	PS6822	HUBBELL POWER SYSTEMS	150
	71011746MACLEAN	Curved Square Washer, 3" x 3" x 5/16", 5/8" Bolt	CW33-5	MACLEAN POWER SYSTEMS	50
	71011541CHANCE	Curved Square Washer, 3" x 3" x 1/4", 5/8" Bolt	682312	HUBBELL POWER SYSTEMS	50
	71011541JOSLYN	Curved Square Washer, 3" x 3" x 1/4", 5/8" Bolt	J113	MACLEAN POWER SYSTEMS	50
	71011541POWERLINEH	Curved Square Washer, 3" x 3" x 1/4", 5/8" Bolt	P113	POWER LINE HARDWARE LLC	100
	71011341CHANCE	Curved Square Washer, 3" x 3" x 1/4", 3/4" Bolt	682212	HUBBELL POWER SYSTEMS	50
	71011341JOSLYN	Curved Square Washer, 3" x 3" x 1/4", 3/4" Bolt	J6823	MACLEAN POWER SYSTEMS	50
	71011341POWERLINEH	Curved Square Washer, 3" x 3" x 1/4", 3/4" Bolt	P6823	POWER LINE HARDWARE LLC	100
	71023654CHANCE	Curved Square Washer, 3-1/4" x 3-1/4" x 1/4", 3/4" Bolt	6825	HUBBELL POWER SYSTEMS	50
	71013051CHANCE	Curved Square Washer, 4" x 4" x 3/16", 3/4" Bolt	DF4W15	HUBBELL POWER SYSTEMS	50
	71013050JOSLYN	Curved Square Washer, 4" x 4" x 1/4", 3/4" Bolt	J6836	MACLEAN POWER SYSTEMS	25
	71013071MACLEAN	Curved Square Washer, 4" x 4" x 1/4", 7/8" Bolt	J6829	MACLEAN POWER SYSTEMS	50
71017880HUGHES	Curved Square Washer, 4" x 4" x 1/4", 7/8" Bolt	SCW4-80	HUGHES BROTHERS	50	
	71013653CHANCE	Cast Ductile Iron Square Curved Washer, 4" x 4", 3/4" Bolt	GCW41	HUBBELL POWER SYSTEMS	50
	71050814CHANCE	Spring Lock Washer, 1/2" Bolt	C205-0185	HUBBELL POWER SYSTEMS	750
	71050816CHANCE	Spring Lock Washer, 5/8" Bolt	C205-0186	HUBBELL POWER SYSTEMS	500
	71050817CHANCE	Spring Lock Washer, 3/4" Bolt	C205-0187	HUBBELL POWER SYSTEMS	250
	71050816EM	Spring Lock Washer, 5/8" Bolt	MW5/8	ELECTRICAL MATERIALS CO	250
	71036031CHANCE	Round Washer, 1-3/8" x 9/16", 1/2" Bolt	PS6803	HUBBELL POWER SYSTEMS	1000
	71020455CHANCE	Round Washer, 1-3/4" x 5/8", 5/8" Bolt	6805	HUBBELL POWER SYSTEMS	500
	71014055HUGHES	Round Washer, 2" x 1/4", 7/8" Bolt	RW2-80	HUGHES BROTHERS	200
	71050050CHANCE	Spring Clip Washer, 1/2" Bolt	3539	HUBBELL POWER SYSTEMS	200
	71050058CHANCE	Spring Clip Washer, 5/8" Bolt	3540	HUBBELL POWER SYSTEMS	50
	71050034CHANCE	Spring Clip Washer, 3/4" Bolt	3541	HUBBELL POWER SYSTEMS	50
	71050060CHANCE	Spring Clip Washer, 3/4" Bolt	C205-0438	HUBBELL POWER SYSTEMS	50
	71050078CHANCE	Spring Clip Washer, 7/8" Bolt	C205-0436	HUBBELL POWER SYSTEMS	50
	71050080MACLEAN	Spring Clip Washer, 7/8" Bolt	J3542	MACLEAN POWER SYSTEMS	50

Madison, WI

Mt. Pleasant, MI

Williston, ND

Kearney, NE









Moorhead, MN

Elkhart, IA

Pierre, SD

# HARDWARE

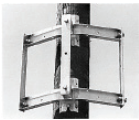
IMAGE	RESCO PART #	DESCRIPTION	MFR MODEL #	MANUFACTURER	PACK. QTY.
	71050078HUGHES	Spring Clip Washer, 7/8" Bolt	2702.8	HUGHES BROTHERS	50
	71050085HUGHES	Spring Clip Washer, 1" Bolt	2702.1	HUGHES BROTHERS	1
	61802000CHANCE	Diamond Point Staple, 1-1/2" x 0.148"	751134	HUBBELL POWER SYSTEMS	50
	61802001REDMORE	Cut Point Utility Staple, 1-1/2"	CG1525K	MINERALLAC COMPANY	50
	61802420REDMORE	Copperclad Cut Point Utility Staple, 1-1/2" x 0.162"	CC1538Q	MINERALLAC COMPANY	50
	61802002KING	Ground Wire Staple, 1/2" x 2"	00094	KING MANUFACTURING CO	50
	61802931REDMORE	Copperclad Cut Point Utility Staple, 2" x 0.162"	CC2050Q	MINERALLAC COMPANY	
	61800902REDMORE	Molding Staple, 2" x 0.187"	DZ2063S(S)	MINERALLAC COMPANY	100
	61804434HUGHES	Ground Wire Molding Staple, 3" x 1-11/16"	25034	HUGHES BROTHERS	1
	12301301CHANCE	Spool Clevis, 2-3/8" x 4-1/16", No Insulator	0341	HUBBELL POWER SYSTEMS	50
	12301301JOSLYN	Spool Clevis, 2-3/8", No Insulator	J0313	MACLEAN POWER SYSTEMS	50
	07804500CHANCE	Spool Clevis, 3-1/4" x 4", No Insulator	0327	HUBBELL POWER SYSTEMS	25
	07804500JOSLYN	Spool Clevis, 3-1/4" x 4", No Insulator	J1300	MACLEAN POWER SYSTEMS	25

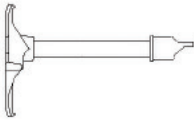
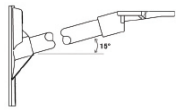
IMAGE	RESCO PART #	DESCRIPTION	MFR MODEL #	MANUFACTURER	PACK. QTY.
	12301201CHANCE	Spool Clevis, 3-1/4" x 5", No Insulator	0352	HUBBELL POWER SYSTEMS	30
	12301304CHANCE	Spool Clevis, 3-5/16", No Insulator	0340	HUBBELL POWER SYSTEMS	25
	12301201JOSLYN	Spool Clevis, 3-3/8" x 5", No Insulator	J0322	MACLEAN POWER SYSTEMS	25
	07805500CHANCE	Offset Neutral Bracket, 15"	C206-0004	HUBBELL POWER SYSTEMS	1
	07805501CHANCE	Neutral Extension Bracket	DC6N1	HUBBELL POWER SYSTEMS	10
	07806600CHANCE	Wing-Type Cluster Mounting Bracket, 3-50KVA	DT6C1	HUBBELL POWER SYSTEMS	1
	07806601CHANCE	Wing-Type Cluster Mounting Bracket, 3-333KVA	DT7C1	HUBBELL POWER SYSTEMS	1
	31002495CHANCE	Transformer Bracket, Wing-Rack Type	C12MW24B	HUBBELL POWER SYSTEMS	1
	07806600JOSLYN	Transformer Mount, 3-50KVA	J6865	MACLEAN POWER SYSTEMS	1
	07806805CHANCE	Aluminum Banded Mount Transformer Bracket	C6M3-6	HUBBELL POWER SYSTEMS	1
	07806808CHANCE	Aluminum Banded Mount Transformer Bracket, 3 50KVA LUG A	C3MW24A	HUBBELL POWER SYSTEMS	1
	07806606HUBBELL	Aluminum Banded Mount Transformer Bracket	C15M3-6	HUBBELL POWER SYSTEMS	1
	07815115CHANCE	1-Position, Single-Phase Cutout/Arrester Bracket, 15", 15"	1SBM15AMB	HUBBELL POWER SYSTEMS	6
	07806840JOSLYN	Single-Phase Cutout/Arrester Bracket, 15"	G1MA0115DCB	MACLEAN POWER SYSTEMS	10
	34276040CHANCE	3-Position Cloverleaf Single-Phase Cutout/Arrester Bracket, 18"	1SBM18CLH	HUBBELL POWER SYSTEMS	5

Madison, WI

Mt. Pleasant, MI

Williston, ND

Kearney, NE

Moorhead, MN

Elkhart, IA

Pierre, SD

# HARDWARE

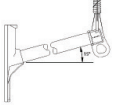
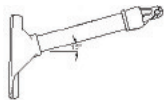
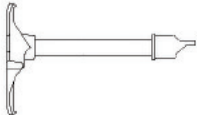

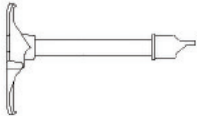





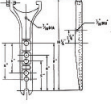

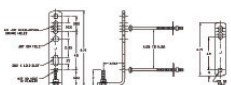
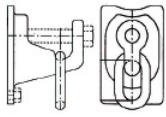





IMAGE	RESCO PART #	DESCRIPTION	MFR MODEL #	MANUFACTURER	PACK. QTY.
	07815110CHANCE	1-Position, Single-Phase Cutout/Arrester Bracket, 15°, 18"	1SBM18AMB	HUBBELL POWER SYSTEMS	6
	07815118CHANCE	Single-Phase Vertical Pin Standoff Bracket, 15°, 18"	1SBM18V1	HUBBELL POWER SYSTEMS	6
	34257380MACLEAN	Post Insulator Suspension Bracket, 24"	G1XAA124DE	MACLEAN POWER SYSTEMS	1
	07806855MACLEAN	2-Position, Single-Phase Cutout/Arrester Bracket, 13"	G1MA0113DDB	MACLEAN POWER SYSTEMS	10
	07806856HUBBELL	2-Position, Single-Phase Cutout/Arrester Bracket, 15"	1SBM15CTB	HUBBELL POWER SYSTEMS	5
	07806856MACLEAN	2-Position, Single-Phase Cutout/Arrester Bracket, 15"	G1MA0118DDB	MACLEAN POWER SYSTEMS	8
	07806858HUBBELL	2-Position, Single-Phase Cutout/Arrester Bracket, 18"	1SBM18CTB	HUBBELL POWER SYSTEMS	5
	07806845HUBBELL	2-Position, 3-Phase Cutout/Arrester Bracket, 36" x 13"	3SBM3613CTB	HUBBELL POWER SYSTEMS	5
	07801813HUBBELL	2-Position, 3-Phase Cutout/Arrester Bracket, 48" x 13"	3SBM4813CTB	HUBBELL POWER SYSTEMS	5
	07806820CHANCE	3-Phase Terminator and Arrester Bracket, 36" x 16" x 12"	CTBEMB16PA35	HUBBELL POWER SYSTEMS	4
	07806845MACLEAN	3-Phase Cutout/Arrester Bracket, 36" x 13"	G3MA013613DDB	MACLEAN POWER SYSTEMS	1
	07802818HUBBELL	3-Position, 3-Phase (Cloverleaf) Cutout/Arrester Bracket, 48" x 18"	3SBM4818CLH	HUBBELL POWER SYSTEMS	5
	07806918MACLEAN	3-Phase Cutout/Arrester Bracket, 48" x 13"	G3MA024813DDX	MACLEAN POWER SYSTEMS	10

IMAGE	RESCO PART #	DESCRIPTION	MFR MODEL #	MANUFACTURER	PACK. QTY.
	07806844MACLEAN	3-Phase Cutout/Arrester Bracket, 48" x 13"	G3MA024813DDB	MACLEAN POWER SYSTEMS	10
	39752230MACLEAN	Trunnion Bracket, 5/8" Bolts	BTA55	MACLEAN POWER SYSTEMS	10
	07806872CHANCE	"D" Pole Mounting Bracket	C206-0299	HUBBELL POWER SYSTEMS	5
	07801502CHANCE	NEMA Heavy Duty "B" Bracket with 1-1/2" Captive Bolt for Crossarm Mounting	C206-0283	HUBBELL POWER SYSTEMS	20
	07806875CHANCE	"L" Type Crossarm Bracket	273456-3001	HUBBELL POWER SYSTEMS	1
	07806875JOSLYN	"L" Type Crossarm Bracket	J24515	MACLEAN POWER SYSTEMS	25
	07807520MACLEAN	Shield Wire Support Bracket, 5/8"	SWBR-6-4-L	MACLEAN POWER SYSTEMS	10
	64001200HUGHES	Shield Wire Support, 5/8" x 12"	2859.1-12	HUGHES BROTHERS	8
	64001400HUGHES	Shield Wire Support, 5/8" x 14"	2859.1-14	HUGHES BROTHERS	8
	64001420HUGHES	Shield Wire Support, 5/8" x 16"	2859.1-16	HUGHES BROTHERS	8
	07807515CHANCE	Static Wire Support, 11-3/4", 8" - 10" Pole Diameter	5432	HUBBELL POWER SYSTEMS	10
	81000129	Static Wire Support, 13-3/4", 10" - 12" Pole Diameter	5433	HUBBELL POWER SYSTEMS	10
	64001400HUBBELL	Static Wire Support, 15-3/4", 12" - 14" Pole Diameter	5434	HUBBELL POWER SYSTEMS	6
	07807505HUBBELL	Pole Top Bracket, 13"	IB3	HUBBELL POWER SYSTEMS	6
	07807503MACLEAN	Pole Top Bracket, 13"	BPT-58F	MACLEAN POWER SYSTEMS	8
	07807503HUBBELL	Pole Top Bracket, 13-3/4"	IB4	HUBBELL POWER SYSTEMS	6

Madison, WI

Mt. Pleasant, MI

Williston, ND

Kearney, NE

Moorhead, MN

Elkhart, IA

Pierre, SD

# HARDWARE





















IMAGE	RESCO PART #	DESCRIPTION	MFR MODEL #	MANUFACTURER	PACK. QTY.
	07806900HUBBELL	Pole Top Bracket, Extending, 22-1/2"	PSC2060842	HUBBELL POWER SYSTEMS	1
	45412111CHANCE	Insulator Crossarm Pin, 10-3/4", 1" Lead Thread	881	HUBBELL POWER SYSTEMS	25
	45412112CHANCE	Insulator Crossarm Pin, 10-3/4", 1" Nylon Thread	881P	HUBBELL POWER SYSTEMS	25
	45412112JOSLYN	Insulator Crossarm Pin, 10-3/4", 1" Nylon Thread	J203Z	MACLEAN POWER SYSTEMS	25
	45412112POWERLINEH	Insulator Crossarm Pin, 10-3/4", 1" Nylon Thread	P203Z	POWER LINE HARDWARE LLC	40
	45412133CHANCE	High Voltage Insulator Crossarm Pin, 14", 1-3/8" Lead Thread	4717	HUBBELL POWER SYSTEMS	10
	45413111CHANCE	Short Shank Line Post Stud, 5/8" x 1-3/4"	DF19M1	HUBBELL POWER SYSTEMS	100
	45412243HUBBELL	Short Shank Line Post Stud, 3/4" x 1-3/4"	DF19M3	HUBBELL POWER SYSTEMS	100
	45413111LAPP	Short Shank Line Post Stud, 5/8" x 2-7/8"	301613	GAMMA INSULATORS CORP.	100
	45412244CHANCE	Long Shank Line Post Stud, 5/8" x 7"	DF19M2	HUBBELL POWER SYSTEMS	25
	45412250CHANCE	Long Shank Line Post Stud, 3/4" x 7"	DF19M4	HUBBELL POWER SYSTEMS	25
	45518779CHANCE	Crossarm Corner Pin, 5", 1" Lead Thread	PS8779	HUBBELL POWER SYSTEMS	10
	45611115CHANCE	2-Hole Pole Top Insulator Pin, 15", 1" Lead Thread	2162	HUBBELL POWER SYSTEMS	15
	45612115JOSLYN	2-Hole Pole Top Insulator Pin, 15", 1" Lead Thread	J715Z	MACLEAN POWER SYSTEMS	20
	45611120CHANCE	2-Hole Pole Top Insulator Pin, 20", 1" Lead Thread	2199	HUBBELL POWER SYSTEMS	10
	45411124CHANCE	Pole Top Insulator Pin, 20", 1" Nylon Threads	2199P	HUBBELL POWER SYSTEMS	10
	45411124JOSLYN	Pole Top Insulator Pin, 20", 1" Nylon Threads	J740Z	MACLEAN POWER SYSTEMS	15
	45411151POWERLINEH	Pole Top Insulator Pin, 20", 1-3/8" Thread Diameter	P720	POWER LINE HARDWARE LLC	15



IMAGE	RESCO PART #	DESCRIPTION	MFR MODEL #	MANUFACTURER	PACK. QTY.
	45612170CHANCE	3-Hole Pole Top Insulator Pin, 18", 1" Lead Thread	2170	HUBBELL POWER SYSTEMS	15
	45612175CHANCE	3-Hole Pole Top Insulator Pin, 20", 1" Lead Thread	2174P	HUBBELL POWER SYSTEMS	10
	45612320JOSLYN	3-Hole Pole Top Insulator Pin, 20", 1" Lead Thread	J720Z	MACLEAN POWER SYSTEMS	15
	45612320CHANCE	3-Hole Pole Top Insulator Pin, 20", 1-3/8" Lead Thread	2195	HUBBELL POWER SYSTEMS	10
	45613118CHANCE	Pole Top Insulator Pin, 21", 1-3/8" Lead Thread	C206-0271	HUBBELL POWER SYSTEMS	10
	45411151CHANCE	Crossarm Clamp Type Insulator Pin, 1" Lead Thread, Two 5/8" x 7" Carriage Bolt Assemblies	14322	HUBBELL POWER SYSTEMS	8
	45411152JOSLYN	Crossarm Clamp Type Insulator Pin, 1" Lead Thread, Two 5/8" x 7" Carriage Bolt Assemblies	J3322Z	MACLEAN POWER SYSTEMS	5
	45411171JOSLYN	Crossarm Clamp Type Insulator Pin, 1-3/8" Lead Thread, Two 5/8" x 7" Carriage Bolt Assemblies	J3324Z	MACLEAN POWER SYSTEMS	5
	11711111CHANCE	Thimbleye Anchor Rod Bonding Clamp for Anchor Rod Eyes, 1/2" and 5/8"	G5060	HUBBELL POWER SYSTEMS	250
	11712110CHANCE	Thimbleye Anchor Rod Bonding Clamp for PISA Eyenuts, 1/2" and 5/8"	G5067	HUBBELL POWER SYSTEMS	100
	11712110JOSLYN	Thimbleye Anchor Rod Bonding Clamp for PISA Eyenuts, 1/2" and 5/8"	J26714	MACLEAN POWER SYSTEMS	100
	11712210CHANCE	Thimbleye Anchor Rod Bonding Clamp for PISA Eyenuts, 3/4" and 1"	G5068	HUBBELL POWER SYSTEMS	100
	11712130CHANCE	Twineye Anchor Rod Bonding Clamp for PISA Eyenuts, 5/8", 3/4" and 1"	G5069	HUBBELL POWER SYSTEMS	100
	11712130JOSLYN	Twineye Anchor Rod Bonding Clamp for PISA Eyenuts, 5/8", 3/4" and 1"	J26716	MACLEAN POWER SYSTEMS	100

Madison, WI

Mt. Pleasant, MI

Williston, ND

Kearney, NE

Moorhead, MN

Elkhart, IA

Pierre, SD

# HARDWARE



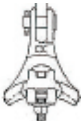
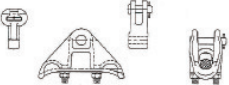
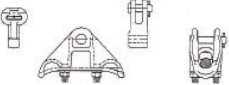









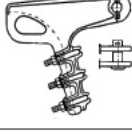



IMAGE	RESCO PART #	DESCRIPTION	MFR MODEL #	MANUFACTURER	PACK. QTY.
	11712430CHANCE	Tripleye Anchor Rod Bonding Clamp for PISA Eyunuts, 5/8", 3/4" and 1"	C203-0148	HUBBELL POWER SYSTEMS	100
	11722204MACLEAN	Angled Suspension Clamp, 0.16 - 0.75 Cable Range	FAC-75	MACLEAN POWER SYSTEMS	20
	11722200MACLEAN	Angled Suspension Clamp, 0.23 - 0.75 Cable Range	RALS-1-N	MACLEAN POWER SYSTEMS	25
	11722210MACLEAN	Angled Suspension Clamp, 0.50 - 1.092 Cable Range	RALS-2-N	MACLEAN POWER SYSTEMS	20
	11742495MACLEAN	Standard Suspension Clamp, 0.16" - 0.46" Cable Range	FSC-46	MACLEAN POWER SYSTEMS	20
	11742492MACLEAN	Standard Suspension Clamp with Socket, 0.16 - 0.46 Cable Range, 16,000 lbs	FSC-46-S	MACLEAN POWER SYSTEMS	15
	11723242MACLEAN	Standard Suspension Clamp, Socket Fitting, 0.40 - 1.05 Clamping Range	LS-2-S	MACLEAN POWER SYSTEMS	15
	11723245MACLEAN	Standard Suspension Clamp, Straight Clevis, 0.40 - 1.05 Clamping Range	LS-2-C	MACLEAN POWER SYSTEMS	15
	11722205MACLEAN	Distribution Strain Clamp, 0.156 - 0.522 Cable Diameter	BT2111	MACLEAN POWER SYSTEMS	25
	11722180MACLEAN	T2 Suspension Clamp, 0.502" - 1" Conductor Range	SC-T2-666-S	MACLEAN POWER SYSTEMS	10
	11722185ANDERSON	T2 Double Groove Deadend Strain Clamp, 226.8 - 556.5 ACSR	SDT2-185S	HUBBELL POWER SYSTEMS	1
	11722196ANDERSON	Bolted Deadend Clamp, 30,000 lbs	SDT2-185HSE-10010	HUBBELL POWER SYSTEMS	1
	11722190PREFORMED	Suspension Cushion Grip Clamp, 2 x 0.684 - 2 x 0.85, 20,000 lbs	CCT2-0005	PREFORMED LINE PRODUCTS	6

IMAGE	RESCO PART #	DESCRIPTION	MFR MODEL #	MANUFACTURER	PACK. QTY.
	11723250PREFORMED	Cushion Grip Suspension, 0.609 - .0883	CGS1096	PREFORMED LINE PRODUCTS	3
	11723227ANDERSON	Deadend Quadrant Strain Clamp, Aluminum, #6 - 3/0 ACSR	DE-46-N	HUBBELL POWER SYSTEMS	40
	11723226ANDERSON	Deadend Quadrant Strain Clamp, Aluminum, #6 - 3/0 ACSR	PG-46-N	HUBBELL POWER SYSTEMS	25
	11723222ANDERSON	Deadend Quadrant Strain Clamp, Aluminum, #4 - 4/0 ACSR	PG-57-N	HUBBELL POWER SYSTEMS	25
	11723215ANDERSON	Deadend Quadrant Strain Clamp, Aluminum, 101.8 - 336.4 ACSR	PG-70-N	HUBBELL POWER SYSTEMS	20
	11724209ANDERSON	Deadend Quadrant Strain Clamp, #6 - 4/0 ACSR	MD-52-N	HUBBELL POWER SYSTEMS	25
	11725538HUBBELL	Deadend Quadrant Strain Clamp, Alumoweld 3 # 10 - Alumoweld 7 # 5	SWDE-55S	HUBBELL POWER SYSTEMS	1
	11723745MACLEAN	Deadend Quadrant Strain Clamp, Aluminum, 3/0 - 556.6 ACSR	ADE-23-C	MACLEAN POWER SYSTEMS	6
	11724589MACLEAN	Deadend Quadrant Strain Clamp, 0.18 - 0.58 Decimal Range, 20,000 lbs	FQD-58-2	MACLEAN POWER SYSTEMS	15
	11725538MACLEAN	Deadend Quadrant Strain Clamp with Socket, 0.18 - 0.58 Decimal Range, 20,000 lbs	FQD-58-3-S	MACLEAN POWER SYSTEMS	10
	11724199FARGO	Automatic Overhead Side-Opening Wedge Clamp, Aluminum, #4 - 2/0 ACSR	GDW2010A	HUBBELL POWER SYSTEMS	25
	11724201FARGO	Automatic Overhead Side-Opening Wedge Clamp, Aluminum, #4 - 4/0 ACSR	GDW2040	HUBBELL POWER SYSTEMS	25
	11722224ANDERSON	Straight-Line, Spring-Loaded, Side-Opening Deadend Clamp, Aluminum, #6 - 2/0 ACSR	ADEZ-47N	HUBBELL POWER SYSTEMS	25
	11722226ANDERSON	Straight-Line, Spring-Loaded, Side-Opening Deadend Clamp, Aluminum, #4 - 4/0 ACSR	ADEZ-57-N	HUBBELL POWER SYSTEMS	25
	11722339ANDERSON	Straight-Line, Spring-Loaded, Side-Opening Deadend Clamp, Aluminum, 2/0 - 556 ACSR	ADEZ-88N	HUBBELL POWER SYSTEMS	10
	11724127ANDERSON	Straight-Line, Spring-Loaded, Side-Opening Deadend Clamp, Aluminum, #6 - 2/0 ACSR	ADSO-46-N	HUBBELL POWER SYSTEMS	25
	11724204ANDERSON	Straight-Line, Spring-Loaded, Side-Opening Deadend Clamp, Aluminum #6 - 2/0 ACSR	ASOD3981N	HUBBELL POWER SYSTEMS	25
	11724205ANDERSON	Straight-Line, Spring-Loaded, Side-Opening Deadend Clamp, Aluminum #4 - 336.4 ACSR	ASOD6841N	HUBBELL POWER SYSTEMS	25

Madison, WI

Mt. Pleasant, MI

Williston, ND

Kearney, NE

Moorhead, MN

Elkhart, IA

Pierre, SD

# HARDWARE



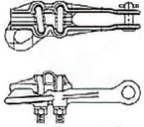

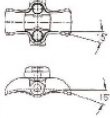
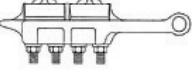



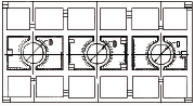







IMAGE	RESCO PART #	DESCRIPTION	MFR MODEL #	MANUFACTURER	PACK. QTY.
	11724200FARGO	Straight-Line, Deadend Strain Clamp, Aluminum #4 - 397.5 ACSR	GD-963A	HUBBELL POWER SYSTEMS	20
	11724265FARGO	Straight-Line, Deadend Strain Clamp, Swing-Away, 3/0 - 556.5 ACSR	GD965A	HUBBELL POWER SYSTEMS	10
	11724226ANDERSON	Straight-Line, Deadend Strain Clamp, Aluminum, #2 - 556.5 ACSR	ADS-88-N	HUBBELL POWER SYSTEMS	20
	11724207ANDERSON	Straight-Line, Strain Deadend Clamp, 0.18" - 0.46" Clamping Range	MDE-46-N	HUBBELL POWER SYSTEMS	15
	11724233MACLEAN	Straight-Line, Deadend Clamp, 0.46 - 0.94 Conductor Range	ASD-45-S	MACLEAN POWER SYSTEMS	10
	11724220MACLEAN	Trunnion Suspension Clamp, Aluminum	ACTS-084	MACLEAN POWER SYSTEMS	50
	11722150MACLEAN	Trunnion Suspension Clamp, 0.25" - 0.57" Conductor Range	LPS-57-F	MACLEAN POWER SYSTEMS	25
	11724245MACLEAN	ASO Style Side-Opening Deadend Clamp, 3/0 - 556.5 ACSR	ASO-858-2N	MACLEAN POWER SYSTEMS	10
	11732240CHANCE	3-Bolted Guy Clamp, 5/8", 6" x 2-1/8"	6460	HUBBELL POWER SYSTEMS	10
	11732291CHANCE	3-Bolted Guy Clamp, 5/8", 6" x 1-21/32"	6461	HUBBELL POWER SYSTEMS	20
	11724113MACLEAN	Copper Deadend Connector, #3 Solid - 6A Copperweld Strand	47-FD	MACLEAN POWER SYSTEMS	50
	11724300FARGO	Automatic Deadend, Copper, Clevis Bail, 4 Solid - 8A Stranded Conductor Range	GD512	HUBBELL POWER SYSTEMS	50
	11724301FARGO	Automatic Deadend, Copper, Clevis Bail, 3 Solid - 6A Stranded Conductor Range	GD513	HUBBELL POWER SYSTEMS	25

IMAGE	RESCO PART #	DESCRIPTION	MFR MODEL #	MANUFACTURER	PACK. QTY.
	11735070PREFORMED	Y-Clevis Eye, 3-1/8" L, 5/8" Pin, 13/16" Bolt	CE-5105	PREFORMED LINE PRODUCTS	20
	11742490MACLEAN	Grid Gain, 9" x 4-1/2", 15/16" Diameter	GRF-9045-7	MACLEAN POWER SYSTEMS	20
	11780019MACLEAN	Wedge Clamp, #2 - #6 ACSR, 6-1/2" Flexible Bail	7195	MACLEAN POWER SYSTEMS	100
	11780019BLACKBURN	Service Wedge Clamp, #2 - #6 ACSR, 11" Flexible Bail	W62-1FC	THOMAS & BETTS	100
	11780025BLACKBURN	Service Wedge Clamp, #4 - 1/0 ACSR	W20-1	THOMAS & BETTS	50
	11780040BLACKBURN	Service Wedge Clamp, 2/0-4/0 ACSR	W40-1	THOMAS & BETTS	50
	11729605CHANCE	Aluminum Body, Snap-On Clamp, 300A	G1810-2	HUBBELL POWER SYSTEMS	1
	11729603CHANCE	Aluminum Body, Snap-On Clamp, 400A	G3622-1	HUBBELL POWER SYSTEMS	1
	17411976ANDERSON	Overhead Primary Tap, Hot Line Tap Clamp, Aluminum, Range 0.128" - 0.414" AAC #8 Solid - #6 Solid w/Armor Rods AAAC #6 Stranded (7) - 1/0 Stranded (7) ACSR #6 (6/1) - 1/0 (6/1) CU #8 Solid - #4 Solid w/Armor Rods	S1520AGP	HUBBELL POWER SYSTEMS	100
	17411937ANDERSON	Overhead Primary Tap, Hot Line Tap Clamp, Bronze, Range 0.128" - 0.414" CU #8 Solid - 2/0 Stranded w/Armor Rods	BC20	HUBBELL POWER SYSTEMS	50
	17411992ANDERSON	Overhead Primary Tap, Hot Line Tap Clamp, Bronze, Range 0.128" - 0.414" CU #8 Solid - 2/0 Stranded w/Armor Rods	BC20FTP	HUBBELL POWER SYSTEMS	50
	17411901ANDERSON	Overhead Primary Tap, Hot Line Tap Clamp, Aluminum, Range 0.157" - 0.905" AAC #6 Stranded - 4/0 Stranded (19) w/Armor Rods AAAC #6 Stranded - 3/0 Stranded (7) w/Armor Rods ACSR #6 (6/1) - 134.6 kcmil (12/7) w/Armor Rods CU #6 Solid - 250 kcmil (37) w/Armor Rods	AH4GP	HUBBELL POWER SYSTEMS	50
	17411904ANDERSON	Overhead Primary Tap, Hot Line Tap Clamp, Aluminum, Range 0.162" - 0.745" AAC #6 Solid - #4 Stranded (7) w/Armor Rods AAAC 6 Stranded (7) - #4 Stranded (7) w/Armor Rods ACSR #6 (6/1) - #4 (6/1) w/Armor Rods CU #6 Solid - #2 Stranded (7) w/Armor Rods	S1530AA	HUBBELL POWER SYSTEMS	50

Madison, WI

Mt. Pleasant, MI

Williston, ND

Kearney, NE

Moorhead, MN

Elkhart, IA

Pierre, SD

# HARDWARE







IMAGE	RESCO PART #	DESCRIPTION	MFR MODEL #	MANUFACTURER	PACK. QTY.
	17411940ANDERSON	Overhead Primary Tap, Hot Line Tap Clamp, Bronze, Range 0.162" - 0.745" CU #6 Solid - 2/0 Stranded (19) w/Armor Rods	S1530CC	HUBBELL POWER SYSTEMS	25
	17411900ANDERSON	Overhead Primary Tap, Hot Line Tap Clamp, Aluminum, Range 0.162" - 0.745" AAC #6 Solid - 2/0 Stranded (19) w/Armor Rods AAAC #6 Stranded (7) - 1/0 Stranded (7) w/Armor Rods ACSR #6 (6/1) - 1/0 (6/1) w/Armor Rods CU #6 Solid - 2/0 Stranded (19) w/Armor Rods	S1530AGP	HUBBELL POWER SYSTEMS	50
	17411972ANDERSON	Overhead Primary Tap, Hot Line Tap Clamp, Aluminum, Range 0.502" - 1.031" AAC 4/0 Stranded (7) - 336.4 kcmil (19) w/Armor Rods AAAC 3/0 Stranded (7) - 312.8 kcmil Stranded (19) w/Armor Rods, ACSR 3/0 (6/1) - 211.3 kcmil (12/7) w/Armor Rods, CU 4/0 Stranded (7) - 250 kcmil (37) w/Armor Rods	S1540AGP	HUBBELL POWER SYSTEMS	50
	17411991ANDERSON	Overhead Primary Tap, Hot Line Tap Clamp, Aluminum, Range 0.939" - 1.49" AAC 700 kcmil (61) - 715.5 kcmil (61) w/Armor Rods AAAC 740.8 kcmil Stranded - 652.8 kcmil Stranded (19) w/Armor Rods, ACSR 636.0 kcmil (18/1) - 605.0 kcmil (26/7) w/Armor Rods, CU 700 kcmil (61) - 1500 kcmil (91)	S1545AGP	HUBBELL POWER SYSTEMS	20
	17412090ANDERSON	Overhead Primary Tap, Hot Line Tap Clamp, Bronze, #8 - 2/0	BH-00	HUBBELL POWER SYSTEMS	50
	17411937JOSLYN	Hot Line Tap Clamp, Range 0.128" - 0.414", CU #8 Solid - 2/0 Stranded	C1520	MACLEAN POWER SYSTEMS	25
	17411900MACLEAN	Hot Line Tap Clamp, Aluminum Body Clamps, Range 0.162" - 0.745", #6 Solid - 400 MCM	C1530A	MACLEAN POWER SYSTEMS	25
	17412078MACLEAN	Hot Line Tap Clamp, Tin-Plated, Range 0.162" - 0.745", #6 Solid - 400 MCM	C1530P	MACLEAN POWER SYSTEMS	25
	17411972JOSLYN	Hot Line Tap Clamp, Range 0.502" - 1.031", 4/0 ACSR - 800 MCM	C1540AP	MACLEAN POWER SYSTEMS	25
	02151113HUGHES	Embossed Tie Plate for a 7-1/2" Arm Depth, 13/16" Mounting Hole	1113.78	HUGHES BROTHERS	1
	11724991ANDERSON	Ductile Deadend Thimble, Type DDT, 0 - 0.875" Conductor Range	DDT-07	HUBBELL POWER SYSTEMS	20

IMAGE	RESCO PART #	DESCRIPTION	MFR MODEL #	MANUFACTURER	PACK. QTY.
	12301004ANDERSON	Socket Eye, 2-1/16" L, 11/16" Diameter, 18,000 lbs	SA04	HUBBELL POWER SYSTEMS	1
	12301005ANDERSON	Socket Eye, 2-1/16" L, 3/4" Diameter, 25,000 lbs	SA06	HUBBELL POWER SYSTEMS	1
	12300513ANDERSON	Socket Eye, 2-1/16" L, 3/4" Diameter, 30,000 lbs	SA10.5-13	HUBBELL POWER SYSTEMS	1
	12300520MACLEAN	Socket Eye, 2-1/16" L, 11/16" Diameter, 30,000 lbs	SI-1750	MACLEAN POWER SYSTEMS	25
	12300513PREFORMED	Socket Eye, 3/4" Diameter, 30,000 lbs	SE5154	PREFORMED LINE PRODUCTS	25
	12301020ANDERSON	Socket Eye, 10" L, 13/16" Diameter, 30,000 lbs	HSE1000613	HUBBELL POWER SYSTEMS	1
	11735060ANDERSON	Y-Clevis Eye, 11/16" Diameter, 20,000 lbs	YCS05	HUBBELL POWER SYSTEMS	1
	11735290ANDERSON	Y-Clevis Eye, 3-1/4" L, 3/4" Pin, 30,000 lbs	YCC3090	HUBBELL POWER SYSTEMS	1
	11735295ANDERSON	Y-Clevis Eye, 3-1/4" L, 3/4" Pin, 30,000 lbs	YCC30	HUBBELL POWER SYSTEMS	1
	12303030ANDERSON	Y-Clevis Ball, 3/4" Curved Bolt, 30,000 lbs	YBC30	HUBBELL POWER SYSTEMS	1
	12301350MACLEAN	Y-Clevis Ball, 3-3/32" x 3/4", 30,000 lbs	YCB-65A	MACLEAN POWER SYSTEMS	25
	11735295MACLEAN	Y-Clevis Eye, 3-5/8" L, 30,000 lbs	YCC-65	MACLEAN POWER SYSTEMS	10
	12301500MACLEAN	Thimble Clevis, 0.88" Groove Diameter, 20,000 lbs	CT-88	MACLEAN POWER SYSTEMS	25
	12301504MACLEAN	Thimble Clevis, 7/8" Groove Diameter, 12,000 lbs	SA-201	MACLEAN POWER SYSTEMS	50
	12301505MACLEAN	Thimble Clevis, 0.88" Groove Diameter, 40,000 lbs	CT-88H	MACLEAN POWER SYSTEMS	25
	12301506MACLEAN	Thimble Clevis, 1" Groove Diameter, 80,000 lbs	CT-100H	MACLEAN POWER SYSTEMS	10
	12301610MACLEAN	Socket Clevis, 30,000 lbs	SCR-55	MACLEAN POWER SYSTEMS	25
	12304016HUBBELL	Clevis Eye, 5/8" Diameter Pin, 2-1/2", 25,000 lbs	CA16	HUBBELL POWER SYSTEMS	1
	12304020MACLEAN	Clevis Eye, 5/8" Diameter Pin, 2-1/2", 18,000 lbs	SCE-55-500	MACLEAN POWER SYSTEMS	25
	12304030MACLEAN	Clevis Eye, 5/8" Diameter Pin, 2-1/2" 30,000 lbs	SCE-55-1375	MACLEAN POWER SYSTEMS	25
	12304016MACLEAN	Clevis Eye, 5/8" Diameter Pin, 2-7/8", 30,000 lbs	SCE-55-1750	MACLEAN POWER SYSTEMS	1

Madison, WI

Mt. Pleasant, MI

Williston, ND

Kearney, NE

Moorhead, MN

Elkhart, IA

Pierre, SD

# HARDWARE

IMAGE	RESCO PART #	DESCRIPTION	MFR MODEL #	MANUFACTURER	PACK. QTY.
	12304040ANDERSON	Clevis-Clevis, 3/4" Diameter Pins, 40,000 lbs	CCC40	HUBBELL POWER SYSTEMS	1
	12304090ANDERSON	Clevis-Clevis, Rotated, 3/4" Diameter Pins, 40,000 lbs	CCC4090	HUBBELL POWER SYSTEMS	1
	12302800CHANCE	Anchor Shackle, 5/8" Diameter Pin, 1/2" x 2-1/2"	5801	HUBBELL POWER SYSTEMS	50
	12302815ANDERSON	Anchor Shackle, 3/4" Diameter Pin, 2-25/32"	AS35	HUBBELL POWER SYSTEMS	1
	12302820ANDERSON	Anchor Shackle, 7/8" Diameter Pin, 3-1/2"	AS50WBK	HUBBELL POWER SYSTEMS	1
	12302850MACLEAN	Anchor Shackle, 5/8" Diameter Pin, 2-3/16"	ASH-45	MACLEAN POWER SYSTEMS	50
	12302804HUGHES	Anchor Shackle, 5/8" Diameter Pin, 1/2" x 2-5/16"	2865.1	HUGHES BROTHERS	50
	31504000CHANCE	Drive Hook, 7/16" Diameter, 4 3/4" Long	C2050190	HUBBELL POWER SYSTEMS	200
	34272030HUGHES	Guy Roller, 7/8" Thickness, 2-3/4" Diameter	28082	HUGHES BROTHERS	50
	34272031HUGHES	Guy Roller, 1" Thickness, 3-1/4" Diameter	28083	HUGHES BROTHERS	25
	75102015CHANCE	Nylon Wireholder, 3", 5/16" Grade 5 Lag Screw	C207-0139	HUBBELL POWER SYSTEMS	50
	75102015JOSLYN	Nylon Wireholder, 3", 11/32" Lag Screw	J0893Z	MACLEAN POWER SYSTEMS	50
	75102023CHANCE	Porcelain Wireholder, No. 22 x 3" Wood Screw	3-11-45	HUBBELL POWER SYSTEMS	50



IMAGE	RESCO PART #	DESCRIPTION	MFR MODEL #	MANUFACTURER	PACK. QTY.
	75103000JOSLYN	Nylon Alloy Service Mast Wireholder	J0588Z	MACLEAN POWER SYSTEMS	25
	11722191CHANCE	Cast Thimble Clevis	TC1	HUBBELL POWER SYSTEMS	25
	02150250HUBBELL	Pole Bearing Plate Anchor Assembly	C11009542	HUBBELL POWER SYSTEMS	1
	12600400KEARNEY	Zinc-Plated Ground Wire Clip, 5/8" x 2-1/2", #4 Stranded Ground Wire Maximum Size	12326	COOPER POWER SYSTEMS	100
	12601538CHANCE	Serving Sleeve, 3/8" Diameter Strand, 1-3/4"	6454	HUBBELL POWER SYSTEMS	500
	12601544CHANCE	Serving Sleeve, 7/16" Diameter Strand, 2"	6455	HUBBELL POWER SYSTEMS	100
	12601540HUGHES	Bonding Clip for 1" Bot, 7/16" Maximum Wire Diameter	2727.1	HUGHES BROTHERS	150
	12601558HUGHES	Bonding Clip for 5/8" Bolt, 5/16" Maximum Wire Diameter	2727.6	HUGHES BROTHERS	500
	12601575HUGHES	Bonding Clip for 3/4" Bolt, 5/16" Maximum Wire Diameter	2727.7	HUGHES BROTHERS	250
	12601578HUGHES	Bonding Clip for 7/8" Bolt, 5/16" Maximum Wire Diameter	2727.8	HUGHES BROTHERS	250
	12602718HUGHES	Bonding Clip with 1/2" Carriage Bolt	2718.55	HUGHES BROTHERS	200
	17371163JOSLYN	Ground Bonding Clamp, 5/8" Mounting Bolt	J1163	MACLEAN POWER SYSTEMS	100
	29300108EM	Leaderguard, 2" - 6"	27-1B	ELECTRICAL MATERIALS CO	1
	29300104EM	Leaderguard, 2" - 2-1/2"	27-2B	ELECTRICAL MATERIALS CO	1

Madison, WI

Mt. Pleasant, MI

Williston, ND

Kearney, NE

Moorhead, MN









Elkhart, IA

Pierre, SD

# HARDWARE

IMAGE	RESCO PART #	DESCRIPTION	MFR MODEL #	MANUFACTURER	PACK. QTY.
	29300863EM	Guy Guard, 8', Yellow without Clamp	70-6YWOC	ELECTRICAL MATERIALS CO	25
	29300867EM	Guy Guard, 8', Yellow Reflective	70-6YRF3	ELECTRICAL MATERIALS CO	25
	29300860EM	Guy Guard, 8', Yellow	70-7Y	ELECTRICAL MATERIALS CO	25
	29300875EM	Guy Guard, 2" x 8', Yellow Full Round	70-7YTIE	ELECTRICAL MATERIALS CO	25
	29300856EM	Guy Guard, 8', Orange without Clamp	70-70R-WOC	ELECTRICAL MATERIALS CO	25
	29300861EM	Guy Guard, 8', Yellow/Orange Stripe	70-7YORS	ELECTRICAL MATERIALS CO	25
	29300862EM	Guy Guard, 8', Yellow without Clamp	70-7Y-WOC	ELECTRICAL MATERIALS CO	25
	29300857EM	Guy Guard, 8', Yellow/Orange Stripe without Clamp	70-70YORWOC	ELECTRICAL MATERIALS CO	25
	29300864RNM	Guy Guard, 8', Yellow	RMYGG-TU-8 (3HD)	R & M PLASTIC PRODUCTS LTD	10
	29300867RNM	Guy Guard, 8', Yellow Reflective	RMYGG-T-U-8.3HDR	R & M PLASTIC PRODUCTS LTD	10
	29304855PREFORMED	Guy Guard, 8', Orange/Yellow	PG-5750	PREFORMED LINE PRODUCTS	25
	34272039HUGHES	Ribbed Tie Plate, 5-3/4" Crossarm, 13/16" Hole	1005.76	HUGHES BROTHERS	1
	34272036HUGHES	Ribbed Tie Plate, 9-1/2" Crossarm, 15/16" Hole	1005.810	HUGHES BROTHERS	25
	34272033HUGHES	Ribbed Tie Plate, 7-3/4" Crossarm, 15/16" HOLE	1005.88	HUGHES BROTHERS	1
	34272037HUGHES	Flat Gain Plate, 5-3/4" Crossarm, 13/16" Hole	1004.76	HUGHES BROTHERS	1
	34272035HUGHES	Flat Gain Plate, 9-1/2" Crossarm, 15/16" Hole	1004.810	HUGHES BROTHERS	25
	34272038HUGHES	Flat Gain Plate, 7-3/4" Crossarm, 15/16" Hole	1004.88	HUGHES BROTHERS	1
	34272047MACLEAN	Extension Link, 10", 5/8" Pin, 15,000 lbs	CEL10	MACLEAN POWER SYSTEMS	25
	37840230ANDERSON	Steel Chain Link, 1 x 2-1/8 Opening, 30,000 lbs	LK-30	HUBBELL POWER SYSTEMS	100
	34272545HUGHES	Guy Link Assembly, 2-1896 Yoke Plates, 2-28082 Guy Rollers, 3-B83 - 2-7/8" x 3" Machine Bolts, 3-N80 7/8" Square Nuts, 3-MF80 7/8" Lock Nuts	TG-92-2	HUGHES BROTHERS	1
	60007501CHANCE	Pole Top Pin Spacer, 1-1/2"	2237	HUBBELL POWER SYSTEMS	250
	60616160HUBBELL	Static Wire Compression Splice, 0.343" - 0.375" Diameter Range	811425	HUBBELL POWER SYSTEMS	1
	63000502LEWIS	Cable Grip, 3/4" - 1-1/4"	U-100-SWB-PGE	LEWIS MFG CO	25
	63000504LEWIS	Cable Grip, 1-1/8" - 1-5/8"	U-112-SWB-PGE	LEWIS MFG CO	25

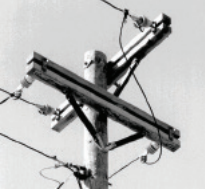
# CROSSARMS

IMAGE/DRAWING	RESCO PART #	DESCRIPTION	MFR MODEL #	MANUFACTURER	PACK. QTY.
	07535123HUBBELL	Wood Crossarm Brace, 38" Span, 18" Drop	PSCAF626	HUBBELL POWER SYSTEMS	10
	07535123HUGHES	Wood Crossarm Brace, 38" Span, 18" Drop	2023	HUGHES BROTHERS	10
	07535166HUBBELL	Wood Crossarm Brace, 60" Span, 18" Drop	PSCRA6018	HUBBELL POWER SYSTEMS	5
	07535167HUGHES	Wood Crossarm Brace, 60" Span, 30" Drop	2045-D45-9-11	HUGHES BROTHERS	5
	07535166BROOKS	Wood Crossarm Brace, 60" Span, 18" Drop	446-60-18	BROOKS MANUFACTURING CO.	5
	07535167BROOKS	Wood Crossarm Brace, 60" Span, 30" Drop	446-60-30	BROOKS MANUFACTURING CO.	120
	07535159BROOKS	Wood Crossarm Brace, 72" Span, 36" Drop	446-72-36	BROOKS MANUFACTURING CO.	5
	18212200BROOKS	Cross Brace, 3-3/4" x 5-3/4", with 7/8" x 14" & 16" MB	6051-12-6	BROOKS MANUFACTURING CO.	1
	18212201BROOKS	Cross Brace, 3-3/4" x 5-3/4" with 7/8" x 16" & 18" MB	6051-12-6-D	BROOKS MANUFACTURING CO.	1
	07535170HUGHES	Wood Double-Arm Dead End Assembly, 3-3/4" x 5-3/4" x 8" Arms, 60" Span, 30" Drop	2890-B	HUGHES BROTHERS	1
	07535171HUGHES	Wood Double-Arm Dead End Assembly, 3-3/4" x 5-3/4" x 8" Arms, 60" Span, 30" Drop	2890-B-G2	HUGHES BROTHERS	1
	07535175HUGHES	Heavy Duty Wood Double-Arm Dead End Assembly, 3-5/8" x 7-1/2" x 8" Arms, 60" Span, 30" Drop	2892-A	HUGHES BROTHERS	1

Madison, WI

Mt. Pleasant, MI

Williston, ND

Kearney, NE

Moorhead, MN

Elkhart, IA

Pierre, SD

# CROSSARMS

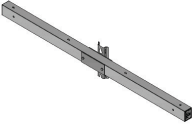
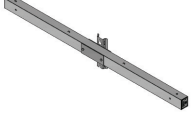
IMAGE/DRAWING	RESCO PART #	DESCRIPTION	MFR MODEL #	MANUFACTURER	PACK. QTY.
	18210211BROOKS	Crossarm Type 2, 3-5/8" x 4-5/8" x 6'	6FT TYPE 2	BROOKS MANUFACTURING CO.	50
	18210911BROOKS	Crossarm Type 3, 3.75" x 4.75" x 8'	8FT TYPE 3	BROOKS MANUFACTURING CO.	50
	18210912BROOKS	Crossarm, 8' Type 03FS Split Bolt 2	TYPE 03FS SPLIT 2	BROOKS MANUFACTURING CO.	50
	18212011BROOKS	Crossarm Type 5, 3.75" x 4.75" x 10'	10FT TYPE 5	BROOKS MANUFACTURING CO.	50
	18212012BROOKS	Crossarm 10' Type 05FS Split Bolt 2	TYPE 05FS SPLIT BOLT 2	BROOKS MANUFACTURING CO.	50
	18212016BROOKS	Crossarm 4-5/8" x 5-5/8" x 16' Treated Bank	4 5/8 X 5 5/8 X 16 X-ARM	BROOKS MANUFACTURING CO.	1
	18212100PUPI	Fiberglass Crossarm, 8' Grey Tangent with Mounting Bracket	TB20009603X2	GEOTEK (PUPI)	1
	18212188PUPI	Fiberglass Crossarm, 8' Grey Tangent with Mounting Bracket	TB220009603X2	GEOTEK (PUPI)	1
	18212101PUPI	Fiberglass Crossarm, 10' Grey Tangent with Mounting Bracket	TB2000-120-052	GEOTEK (PUPI)	1
	18212189PUPI	Fiberglass Crossarm, 10' Grey Tangent with Mounting Bracket	TB220012005X2	GEOTEK (PUPI)	1
	18212135PUPI	Fiberglass Crossarm, 12' Grey, Braceless	TB2500-144-25-02	GEOTEK (PUPI)	35
	18212108PUPI	Fiberglass Deadend, 3W, 10,000 lbs, 8' SD w/Guy	DA250096E2B7X2	GEOTEK (PUPI)	1
	18212109PUPI	Fiberglass Deadend, 2W, 14,700 lbs, 8' HD	DA300096E2B7X2	GEOTEK (PUPI)	1
	18212112PUPI	Fiberglass Deadend, 2W, 7,500 lbs, 10' SD w/Guy	DA2500120E2B92	GEOTEK (PUPI)	1
	18212110PUPI	Fiberglass Deadend, 4W, 10,300 lbs, 10' HD	DA3000120E4B9X2	GEOTEK (PUPI)	1
	18212116PUPI	Extra Heavy Duty Crossarm, 10' FBDSL Grey	DA4000-120E4-B9X2	GEOTEK (PUPI)	1
	18212118PUPI	Fiberglass Deadend 10'	DA4000120E5B9X2	GEOTEK (PUPI)	20
	18212140PUPI	Fiberglass Deadend, 4W, 12,000 lbs, 12'	DA4000-144E4-SPX2	GEOTEK (PUPI)	25

# GROUNDING

IMAGE/DRAWING	RESCO PART #	DESCRIPTION	MFR MODEL #	MANUFACTURER	PACK. QTY.
	17310010ERICO	Ground Rod Clamp, 1/2" - 5/8" Diameter, Silicon Bronze	CP58	ERICO INC	50
	17310012ERICO	Ground Rod Clamp, 1/2" - 3/4" Diameter, Silicon Bronze	CP34	ERICO INC	50
	17311312ERICO	Ground Rod Clamp, 5/8" Diameter, Silicon Bronze	HDC58	ERICO INC	50
	17311337ERICO	Ground Rod Clamp, 5/8" Rod Diameter, Silicon Bronze	HDC58R	ERICO INC	50
	17310011ERICO	Ground Rod Clamp, 1/2" - 5/8" Diameter, Stainless Steel	SP58	ERICO INC	50
	17310230DEMARK	Ground Rod Clamp, 5/8 CU - 6 Solid CU Wire	CO58C6	DEMARK	100
	17311337BLACKBURN	Ground Rod Clamp, 5/8" Rod Size, Copper	JAB58H	THOMAS & BETTS	50
	17311310BLACKBURN	Ground Rod Clamp, 5/8" Rod Size, Copper	GG58H	THOMAS & BETTS	50
	17311337GALVAN	Ground Rod Clamp, 5/8", Bronze	JAB58H	GALVAN INDUSTRIES, INC.	50
	17317175AMP	Ground Rod Clamp, 1/2" - 3/4" Rod Size, Stainless Steel	81412-1	TYCO ELECTRONICS	100

Madison, WI

Mt. Pleasant, MI

Williston, ND

Kearney, NE

Moorhead, MN

Elkhart, IA

Pierre, SD

# GROUNDING

IMAGE/DRAWING	RESCO PART #	DESCRIPTION	MFR MODEL #	MANUFACTURER	PACK. QTY.
	01100510EEI	Anode 5lb Mag Hi Pot 10' Lead	5D3GG	ENERGY ECONOMICS INC.	1
	01101710EEI	Anode 17lb Mag Hi Pot 10' Lead	17D3GG	ENERGY ECONOMICS INC.	1
	46800424BLACKBURN	7.5" Ground Plate Type GP, Copper Pole for Wire Range #2 Solid - #8 Stranded	GP100	THOMAS & BETTS	40
	46800110BLACKBURN	10" Ground Plate Type GP, Copper Pole for Wire Range #2 Solid - #8 Stranded	GP110	THOMAS & BETTS	50
	53822137HUGHES	Grounding Platform, 2'-6" x 4' x 2"	A2137-E	HUGHES BROTHERS	1
	53828506ERICO	Copper-Bonded Ground Rod, Pointed, 13 mil, 5/8" X 6'	615863	ERICO INC	5
	53828500ERICO	Copper-Bonded Ground Rod, Pointed, 13 mil, 5/8" X 8'	615883	ERICO INC	5
	53848508ERICO	Galvanized Ground Rod, Pointed, 5/8" X 8'	815880	ERICO INC	5
	53848508GALVAN	Galvanized Ground Rod, 5/8" X 8'	GR6258F	GALVAN INDUSTRIES, INC.	5
	53828520ERICO	Copper-Bonded Ground Rod, Pointed, 13 mil, 5/8" X 10'	615803	ERICO INC	5
	53968602BLACKBURN	Threadless Ground Rod Coupling, 5/8", Length 2.5"	60CNT2	THOMAS & BETTS	25
	53968603ERICO	Threadless Compression Coupler, 5/8", Length 2.75"	CC58	ERICO INC	25
	78205238ERICO	Plus One Shot, 5/8" Rod, #3 - #4 Solid, #4 - #6 Stranded, Electronic Ignition	GT1-161LPLUS	ERICO INC	6
	78205240ERICO	Plus One Shot, 5/8" Rod, #3 - #4 Solid, #4 - #6 Stranded, Electronic Ignition	GR1-161GPLUS	ERICO INC	6
	78205241ERICO	Plus One Shot, 5/8" Rod, #3 - #4 Solid, #4 - #6 Stranded, Electronic Ignition	GT1-161GPLUS	ERICO INC	6

CORPORATE – WISCONSIN

**Office/ Warehouse**

2250 Pinehurst Drive  
Middleton, WI 53562  
Sales Support: (800) 356-9370

MINNESOTA

**Office/Warehouse**

4100 30<sup>th</sup> Avenue South  
Moorhead, MN 56560  
Sales Support: (800) 346-3330

IOWA

**Office/Warehouse**

1308 NW Laurel Street  
Elkhart, IA 50073  
Sales Support: (888) 293-7372

MICHIGAN

**Warehouse**

1640 Gover Parkway  
Mt. Pleasant, MI 48858  
Sales Support: (800) 356-9370

NORTH DAKOTA

**Warehouse**

508 58<sup>th</sup> Street West  
Williston, ND 58801  
Sales Support: (800) 346-3330

SOUTH DAKOTA

**Warehouse**

3715 Airport Road  
Pierre, SD 57501  
Sales Support: (800) 346-3330

NEBRASKA

**Warehouse**

404 West 8<sup>th</sup> Street  
Suite 2  
Kearney, NE 68845  
Sales Support: (888) 293-7372

[info@resco1.com](mailto:info@resco1.com)

[www.resco1.com](http://www.resco1.com)

STORM RESPONSE

(866) 273-5030

**RESCO**

