

CABLE ACCESSORIES

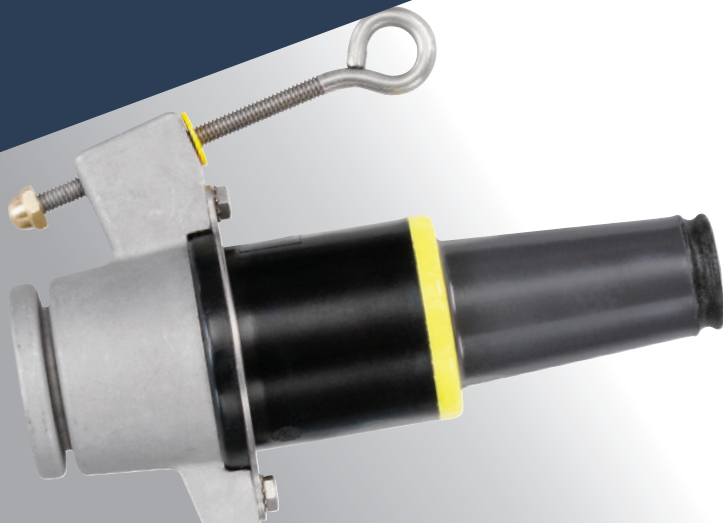

RESCO
SUPPLYING THE COOPERATIVE ADVANTAGE



TABLE OF CONTENTS

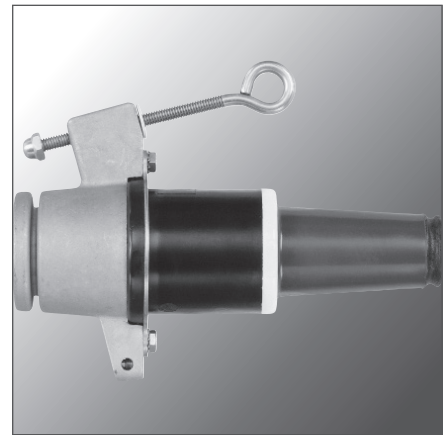



Terminators.....4 - 6

Loadbreak Elbows6 - 10

Deadbreak Elbows..... 10 - 11

Elbow Accessories 11

200A Accessories 12 - 13

Splices..... 13 - 16

Junctions..... 16 - 17

Surge Arresters 17

Grounding Products 17 - 18



Madison, WI

Mt. Pleasant, MI

Williston, ND

Kearney, NE

Moorhead, MN

Elkhart, IA

Pierre, SD

CABLE ACCESSORIES

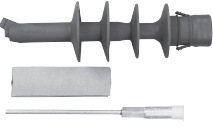

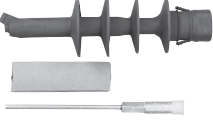

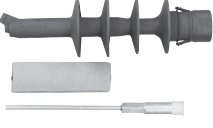

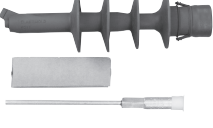











IMAGE	RESCO PART #	DESCRIPTION	MFR MODEL #	MANUFACTURER	PACK. QTY.
	66860148ELASTIMOLD	Terminator One Piece, 15kV, 2 SOL/Compact, Insulation Diameter 0.640" - 1.07"	PCT1-0210-4	THOMAS & BETTS	1
	66900009MMM	Outdoor Termination Kit, 15kV for Jacketed Concentric Neutral Cable, 2 SOL, Cable Insulation O.D. 0.637" - 1.12", With Connector	5641-2	3M ELECTRICAL PRODUCTS	1
	66860150ELASTIMOLD	Terminator One Piece, 15kV, 1 STR - 1/0 SOL, Insulation Diameter 0.640" - 1.07"	PCT1-1230-4	THOMAS & BETTS	1
	66860251ELASTIMOLD	Terminator One Piece, 15kV, 1 STR - 1/0 SOL, Insulation Diameter 0.775" - 0.885"	16THG-GA-1230-4	THOMAS & BETTS	1
	66871230ELASTIMOLD	Terminator One Piece, 15kV, 1 STR - 1/0 SOL, Insulation Diameter 0.875" - 0.985"	16THG-GB-1230-4	THOMAS & BETTS	1
	66860154ELASTIMOLD	Terminator One Piece, 15kV, 4/0 STR, Insulation Diameter 0.640" - 1.07"	PCT1-1270-4	THOMAS & BETTS	1
	66900014MMM	Outdoor Termination Kit, 15kV for Jacketed Concentric Neutral Cable, 4/0 STR, Cable Insulation O.D. 0.84" - 1.38", With Connector	5642-4/0	3M ELECTRICAL PRODUCTS	1
	66860161ELASTIMOLD	Terminator One Piece, 25kV, 1 STR - 1/0 SOL, Insulation Diameter 0.830" - 1.18"	PCT2-1230-4	THOMAS & BETTS	1
	66871250ELASTIMOLD	Terminator One Piece, 25kV, 4/0 STR, CU/AL, Insulation Diameter 0.980" - 1.115"	16THG-HA-0270-4	THOMAS & BETTS	1
	66860165ELASTIMOLD	Terminator One Piece, 25kV, 4/0 STR, Insulation Diameter 0.830" - 1.18"	PCT2-1270-4	THOMAS & BETTS	1

IMAGE	RESCO PART #	DESCRIPTION	MFR MODEL #	MANUFACTURER	PACK. QTY.
	66900016RAYCHEM	Terminator One Piece, 15kV, #2 - 250kcmil Insulation Diameter: 0.64\" - 1.09\"	TFT-151E	TYCO ELECTRONICS	1
	60100152RAYCHEM	Terminator, Tool Free, 15kV, 4/0 - 500, 0.85\" - 1.45\"	TFT-152E	TYCO ELECTRONICS	1
	66900016MMM	Outdoor Termination Kit, 5kV - 15kV for Concentric and Jacketed Concentric Neutral Cable, Cable Insulation Diameter 0.64\" - 1.08\" 5kV Range: 4/0 - 400kCMIL 15kV Range: 2 - 4/0 AWG	7642-S-2	3M ELECTRICAL PRODUCTS	1
	60100051RAYCHEM	Heat Shrink Terminator, Outdoor, 15kV, #2 - 3/0 AWG, Insulation Diameter 0.65 - 1.00, Jacketed and Unjacketed URD Cable	HVT-151-SJ	TYCO ELECTRONICS	1
	60100052RAYCHEM	Heat Shrink Terminator, Outdoor, 15kV, 4/0 - 350 AWG/ kcmil, Insulation Diameter 0.85 - 1.40, Jacketed and Unjacketed URD Cable	HVT-152-SJ	TYCO ELECTRONICS	1
	60714908MMM	Outdoor Termination Kit, 5kV - 15kV for Non-Jacketed Concentric Neutral Cable Diameter 0.84\" - 1.38\" 5kV Range: 350 - 750kCMIL 15kV Range: 250 - 500kCMIL	5602	3M ELECTRICAL PRODUCTS	1
	66900004MMM	Outdoor Termination Kit, 5kV - 28kV for Concentric and Jacketed Concentric Neutral Cable, Cable Insulation Diameter 1.05\" - 1.80\" 5kV Range: 700 - 1500kCMIL 15kV Range: 500 - 1000kCMIL 25/28kV Range: 250 - 800kCMIL	7655-S-4	3M ELECTRICAL PRODUCTS	1
	66890222ELASTIMOLD	Terminator Support Bracket, Universal	16TB-2	THOMAS & BETTS	1
	66890226ELASTIMOLD	Terminator Support Bracket, For Riser Pole Applications	16TB-4	THOMAS & BETTS	1
	66860158ELASTIMOLD	PCT Terminator Positioning Bracket, Fits Cable O.D. Range 0.750\" - 1.625\"	PB-1-EM	THOMAS & BETTS	1
	07803837HUBBELL	Cable Positioner, 3/4\" - 3\" Cable Diameter Range	CCS-820	HUBBELL POWER SYSTEMS	36
	66890232RAYCHEM	Terminator Mounting Bracket, 0.80\" - 1.25\"	BRKT-1-SS	TYCO ELECTRONICS	1
	66890232MMM	Terminator Mounting Bracket, .80-1.25\"	MB-3	3M ELECTRICAL PRODUCTS	10
	66890233MMM	Terminator Mounting Bracket, 1.10\" - 1.50\"	MB-4	3M ELECTRICAL PRODUCTS	10

Madison, WI

Mt. Pleasant, MI

Williston, ND

Kearney, NE

Moorhead, MN

Elkhart, IA

Pierre, SD

CABLE ACCESSORIES

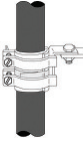





IMAGE	RESCO PART #	DESCRIPTION	MFR MODEL #	MANUFACTURER	PACK. QTY.
	66890234MMM	Terminator Mounting Bracket, 1.45" - 1.95"	MB-5	3M ELECTRICAL PRODUCTS	10
	66890236MMM	Terminator Mounting Bracket, 1.80" - 2.40"	MB-6	3M ELECTRICAL PRODUCTS	1
	66900022MMM	Terminator Stem Connector, Up to 35kV, for Aluminum or Copper Conductor 1-1/0 AWG Solid or 2-1 AWG Stranded	SC0001	3M ELECTRICAL PRODUCTS	10
	66900024MMM	Terminator Stem Connector, Up to 35kV, for Aluminum or Copper Conductor 4/0 AWG Stranded	SC0040	3M ELECTRICAL PRODUCTS	10
	67900014FARGO	Riser Tie for Vertical Support, PVC, 14" Length Range: 0.920" - 1.125" With Aluminum Mounting Bracket	GJ-855-8	HUBBELL POWER SYSTEMS	100
	67900016FARGO	Riser Tie for Vertical Support, PVC, 15" Length Range: 1.126" - 1.50" With Aluminum Mounting Bracket	GJ-856-8	HUBBELL POWER SYSTEMS	100
	67900013FARGO	Riser Tie for Vertical Support, PVC, 15" Length Range: 1.126" - 1.50"	GJ-856	HUBBELL POWER SYSTEMS	100
	66930094ELASTIMOLD	Elbow, Loadbreak 15kV 200A, Range: 0.635" - 0.905" Conductor: #3 Stranded/Compressed or #2 Solid/Compact	165LR-B-5210	THOMAS & BETTS	1
	66930894ELASTIMOLD	Elbow, Loadbreak 15kV 200A, Range: 0.635" - 0.905" Conductor: #3 Stranded/Compressed or #2 Solid/Compact	161LR-B-5210	THOMAS & BETTS	1
	66930154ELASTIMOLD	Elbow, Loadbreak With Test Point 15kV 200A, Range: 0.635" - 0.905", Conductor: #3 Stranded/Compressed or #2 Solid/Compact	166LR-B-5210	THOMAS & BETTS	1
	66930854ELASTIMOLD	Elbow, Loadbreak With Test Point 15kV 200A, Range: 0.635" - 0.905", Conductor: #3 Stranded/Compressed or #2 Solid/Compact	162LR-B-5210	THOMAS & BETTS	1
	66931754ELASTIMOLD	Elbow, Loadbreak With Jacket Seal 15kV 200A, Range: 0.635" - 0.905", Conductor: #3 Stranded/Compressed or #2 Solid/Compact	165LRJS-B-5210	THOMAS & BETTS	1
	66931854ELASTIMOLD	Elbow, Loadbreak With Jacket Seal 15kV 200A, Range: 0.635" - 0.905", Conductor: #3 Stranded/Compressed or #2 Solid/Compact	161LRJS-B-5210	THOMAS & BETTS	1

IMAGE	RESCO PART #	DESCRIPTION	MFR MODEL #	MANUFACTURER	PACK. QTY.
	66931761ELASTIMOLD	Elbow, Loadbreak With Test Point and Jacket Seal 15kV 200A, Range: 0.635" - 0.905", Conductor: #3 Stranded/Compressed or #2 Solid/Compact	166LRJS-B-5210	THOMAS & BETTS	1
	66931861ELASTIMOLD	Elbow, Loadbreak With Test Point and Jacket Seal 15kV 200A, Range: 0.635" - 0.905", Conductor: #3 Stranded/Compressed or #2 Solid/Compact	1612RJS-B-5210	THOMAS & BETTS	1
	66931765ELASTIMOLD	Elbow, Loadbreak With Test Point and Jacket Seal 15kV 200A, Range: 0.635" - 0.905", Conductor: #2 Stranded/Compressed or #1 Solid/Compact	166LRJS-B-5220	THOMAS & BETTS	1
	66931865ELASTIMOLD	Elbow, Loadbreak With Test Point and Jacket Seal 15kV 200A, Range: 0.635" - 0.905", Conductor: #2 Stranded/Compressed or #1 Solid/Compact	1612RJS-B-5220	THOMAS & BETTS	1
	66930112ELASTIMOLD	Elbow, Loadbreak 15kV 200A, Range: 0.635" - 0.905" Conductor: #1 Stranded/Compressed or 1/0 Solid/Compact	165LR-B-5230	THOMAS & BETTS	1
	66930812ELASTIMOLD	Elbow, Loadbreak 15kV 200A, Range: 0.635" - 0.905" Conductor: #1 Stranded/Compressed or 1/0 Solid/Compact	161LR-B-5230	THOMAS & BETTS	1
	66930113ELASTIMOLD	Elbow, Loadbreak With Test Point 15kV 200A, Range: 0.635" - 0.905", Conductor: #1 Stranded/Compressed or 1/0 Solid/Compact	166LR-B-5230	THOMAS & BETTS	1
	66930813ELASTIMOLD	Elbow, Loadbreak With Test Point 15kV 200A, Range: 0.635" - 0.905", Conductor: #1 Stranded/Compressed or 1/0 Solid/Compact	162LR-B-5230	THOMAS & BETTS	1
	66931755ELASTIMOLD	Elbow, Loadbreak With Jacket Seal 15kV 200A, Range: 0.635" - 0.905", Conductor: #1 Stranded/Compressed or 1/0 Solid/Compact	165LRJS-B-5230	THOMAS & BETTS	1
	66931855ELASTIMOLD	Elbow, Loadbreak With Jacket Seal 15kV 200A, Range: 0.635" - 0.905", Conductor: #1 Stranded/Compressed or 1/0 Solid/Compact	161LRJS-B-5230	THOMAS & BETTS	1
	66931755EHUBBELL	Elbow, Loadbreak With Jacket Seal 15kV 200A, Range: 0.635" - 0.905", Conductor: #1 Stranded/Compressed or 1/0 Solid/Compact	215LEJ44	HUBBELL POWER SYSTEMS	1

Madison, WI

Mt. Pleasant, MI

Williston, ND

Kearney, NE

Moorhead, MN

Elkhart, IA

Pierre, SD

CABLE ACCESSORIES













IMAGE	RESCO PART #	DESCRIPTION	MFR MODEL #	MANUFACTURER	PACK. QTY.
	66931762ELASTIMOLD	Elbow, Loadbreak With Test Point and Jacket Seal 15kV 200A, Range: 0.635" - 0.905"; Conductor: #1 Stranded/Compressed or 1/0 Solid/Compact	166LRJS-B-5230	THOMAS & BETTS	1
	66931862ELASTIMOLD	Elbow, Loadbreak With Test Point and Jacket Seal 15kV 200A, Range: 0.635" - 0.905"; Conductor: #1 Stranded/Compressed or 1/0 Solid/Compact	162LRJS-B-5230	THOMAS & BETTS	1
	66930095ELASTIMOLD	Elbow, Loadbreak 15kV 200A, Range: 0.805" - 1.06" Conductor: #1 Stranded/Compressed or 1/0 Solid/Compact	165LR-C-5230	THOMAS & BETTS	1
	66931095ELASTIMOLD	Elbow, Loadbreak 15kV 200A, Range: 0.805" - 1.06" Conductor: #1 Stranded/Compressed or 1/0 Solid/Compact	161LR-C-5230	THOMAS & BETTS	1
	66930160ELASTIMOLD	Elbow, Loadbreak With Test Point 15kV 200A, Range: 0.635" - 0.905"; Conductor: 1/0 Stranded/Compressed or 2/0 Solid/Compact	166LR-B-5240	THOMAS & BETTS	1
	66930860ELASTIMOLD	Elbow, Loadbreak With Test Point 15kV 200A, Range: 0.635" - 0.905"; Conductor: 1/0 Stranded/Compressed or 2/0 Solid/Compact	162LR-B-5240	THOMAS & BETTS	1
	66931756ELASTIMOLD	Elbow, Loadbreak With Jacket Seal 15kV 200A, Range: 0.635" - 0.905"; Conductor: 1/0 Stranded/Compressed or 2/0 Solid/Compact	165LRJS-B-5240	THOMAS & BETTS	1
	66931856ELASTIMOLD	Elbow, Loadbreak With Jacket Seal 15kV 200A, Range: 0.635" - 0.905"; Conductor: 1/0 Stranded/Compressed or 2/0 Solid/Compact	161LRJS-B-5240	THOMAS & BETTS	1
	66930098ELASTIMOLD	Elbow, Loadbreak 15kV 200A, Range: 0.805" - 1.06" Conductor: 4/0 Stranded/Compressed or 250 Solid/Compact	165LR-C-5270	THOMAS & BETTS	1
	66930898ELASTIMOLD	Elbow, Loadbreak 15kV 200A, Range: 0.805" - 1.06" Conductor: 4/0 Stranded/Compressed or 250 Solid/Compact	161LR-C-5270	THOMAS & BETTS	1

IMAGE	RESCO PART #	DESCRIPTION	MFR MODEL #	MANUFACTURER	PACK. QTY.
	66930166ELASTIMOLD	Elbow, Loadbreak With Test Point 15kV 200A, Range: 0.805" - 1.06", Conductor: 4/0 Stranded/Compressed or 250 Solid/Compact	166LR-C-5270	THOMAS & BETTS	1
	66930866ELASTIMOLD	Elbow, Loadbreak With Test Point 15kV 200A, Range: 0.805" - 1.06", Conductor: 4/0 Stranded/Compressed or 250 Solid/Compact	162LR-C-5270	THOMAS & BETTS	1
	66931759ELASTIMOLD	Elbow, Loadbreak With Jacket Seal 15kV 200A, Range: 0.805" - 1.06", Conductor: 4/0 Stranded/Compressed or 250 Solid/Compact	165LRJS-C-5270	THOMAS & BETTS	1
	66931859ELASTIMOLD	Elbow, Loadbreak With Jacket Seal 15kV 200A, Range: 0.805" - 1.06", Conductor: 4/0 Stranded/Compressed or 250 Solid/Compact	161LRJS-C-5270	THOMAS & BETTS	1
	66931763ELASTIMOLD	Elbow, Loadbreak With Test Point and Jacket Seal 15kV 200A, Range: 0.805" - 1.06", Conductor: 4/0 Stranded/Compressed or 250 Solid/Compact	166LRJS-C-5270	THOMAS & BETTS	1
	66931863ELASTIMOLD	Elbow, Loadbreak With Test Point and Jacket Seal 15kV 200A, Range: 0.805" - 1.06", Conductor: 4/0 Stranded/Compressed or 250 Solid/Compact	162LRJS-C-5270	THOMAS & BETTS	1
	66931763HUBBELL	Elbow, Loadbreak With Test Point and Jacket Seal 15kV 200A, Range: 0.760" - 1.135", Conductor: 4/0 Stranded/Compressed or 250 Solid/Compact	215LEJ58T	HUBBELL POWER SYSTEMS	1
	66930099ELASTIMOLD	Elbow, Loadbreak 15kV 200A, Range: 0.890" - 1.22" Conductor: 4/0 Stranded/Compressed or 250 Solid/Compact	165LR-D-5270	THOMAS & BETTS	1
	66930899ELASTIMOLD	Elbow, Loadbreak 15kV 200A, Range: 0.890" - 1.22" Conductor: 4/0 Stranded/Compressed or 250 Solid/Compact	161LR-D-5270	THOMAS & BETTS	1
	66932550ELASTIMOLD	Elbow, Loadbreak 25kV 200A, Range: 0.635" - 0.905", Conductor: #1 Stranded/Compressed or 1/0 Solid/Compact	275LR-B-5230	THOMAS & BETTS	1
	66932850ELASTIMOLD	Elbow, Loadbreak 25kV 200A, Range: 0.635" - 0.905", Conductor: #1 Stranded/Compressed or 1/0 Solid/Compact	261LR-B-5230	THOMAS & BETTS	1
	66932557ELASTIMOLD	Elbow, Loadbreak 25kV 200A, Range: 0.800" - 1.06", Conductor: #1 Stranded/Compressed or 1/0 Solid/Compact	275LR-CC-5230	THOMAS & BETTS	1
	66932857ELASTIMOLD	Elbow, Loadbreak 25kV 200A, Range: 0.805" - 1.06", Conductor: #1 Stranded/Compressed or 1/0 Solid/Compact	261LR-C-5230	THOMAS & BETTS	1

Madison, WI

Mt. Pleasant, MI

Williston, ND

Kearney, NE

Moorhead, MN

Elkhart, IA

Pierre, SD

CABLE ACCESSORIES







IMAGE	RESCO PART #	DESCRIPTION	MFR MODEL #	MANUFACTURER	PACK. QTY.
	66932763ELASTIMOLD	Elbow, Loadbreak With Jacket Seal 25kV 200A, Range: 0.800" - 1.06", Conductor: #1 Stranded/Compressed or 1/0 Solid/Compact	275LRJS-CC-5230	THOMAS & BETTS	1
	66932863ELASTIMOLD	Elbow, Loadbreak With Jacket Seal 25kV 200A, Range: 0.805" - 1.06", Conductor: #1 Stranded/Compressed or 1/0 Solid/Compact	261LRJS-C-5230	THOMAS & BETTS	1
	66932558ELASTIMOLD	Elbow, Loadbreak 25kV 200A, Range: 0.940" - 1.170", Conductor: 4/0 Stranded/Compressed	275LR-DD-5270	THOMAS & BETTS	1
	66932858ELASTIMOLD	Elbow, Loadbreak 25kV 200A, Range: 0.940" - 1.170", Conductor: 4/0 Stranded/Compressed	261LR-D-5270	THOMAS & BETTS	1
	66890203ELASTIMOLD	Elbow Kit, Deadbreak, 15/25kV 600A, 4/0 STR, 0.980" - 1.18", No Test Point, Kit Includes: Elbow Housing, Lug, Stud, Insulating Plug With Cap, Cable Adapter	K655LR-J-0270	THOMAS & BETTS	1
	66890204ELASTIMOLD	Elbow Kit, Deadbreak, 15/25kV 600A, 500MCM, 1.18" - 1.465", No Test Point, Kit Includes: Elbow Housing, Lug, Stud, Insulating Plug With Cap, Cable Adapter	K655LR-L-0330	THOMAS & BETTS	1
	66890220ELASTIMOLD	Elbow Kit, Deadbreak, 15/25kV 600A 700/750 Stranded/Compressed or 900 Compact, 1.37" - 1.63", No Test Point, Kit Includes: Elbow Housing, Lug, Stud, Insulating Plug With Cap, Cable Adapter	K655LR-M-0380	THOMAS & BETTS	1
	66890201ELASTIMOLD	Elbow, Deadbreak, Connector Housing, 15/25kV 600a, No Test Point	K655BLR	THOMAS & BETTS	1
	66890192ELASTIMOLD	Elbow, Deadbreak, Threaded Stud, 15/25kV	650SA	THOMAS & BETTS	1
	66890190ELASTIMOLD	Elbow Tap Plug, Deadbreak, 15kV 600/200A	650ETP	THOMAS & BETTS	1
	66890210ELASTIMOLD	Reducing Tap Well, Deadbreak 15/25kV 600A	K650RTW	THOMAS & BETTS	1

IMAGE	RESCO PART #	DESCRIPTION	MFR MODEL #	MANUFACTURER	PACK. QTY.
	66890208ELASTIMOLD	Bushing Extender with Stud, Deadbreak, 15/25kV 600A	K655BE	THOMAS & BETTS	1
	66890198ELASTIMOLD	Insulating Cap, Deadbreak, 15/25kV 600A, With Test Point and Cap	K650BIP	THOMAS & BETTS	1
	66890207ELASTIMOLD	Insulating Cap with Test Point and Stud, Deadbreak, 15/25kV, 600A	K656DR	THOMAS & BETTS	1
	66890215ELASTIMOLD	Insulating Cap with Test Point, Stud, and Ground, Deadbreak, 15/25kV 600A	K656DRG	THOMAS & BETTS	1
	66890193ELASTIMOLD	Cable Adapter, Deadbreak, 15/25kV 600A, 0.980" - 1.18"	655CA-J	THOMAS & BETTS	1
	66890194ELASTIMOLD	Cable Adapter, Deadbreak, 15/25kV 600A, 1.180" - 1.465"	655CA-L	THOMAS & BETTS	1
	66890195ELASTIMOLD	Cable Adapter, Deadbreak, 15/25kV 600A, 1.37" - 1.63"	655CA-M	THOMAS & BETTS	1
	66916270ELASTIMOLD	Contact, Deadbreak Aluminum 15/25kV 600A 4/0 Stranded/Compressed or 250 Compact	03700270	THOMAS & BETTS	1
	66916330ELASTIMOLD	Contact, Deadbreak Aluminum 15/25kV 600A 500 Stranded/Compressed or 600 Compact	03700330	THOMAS & BETTS	1
	66916380ELASTIMOLD	Contact, Deadbreak Aluminum 15/25kV 600A 700/750 Stranded/Compressed or 900 Compact	03700380	THOMAS & BETTS	1
	60714915MMM	Cold Shrink Cable Sealing Kit 15kV to 35kV 15kV Range 2 - 4/0 25kV Range 2 - 2/0	8452	3M ELECTRICAL PRODUCTS	10
	60714920MMM	Cold Shrink Cable Sealing Kit 15kV to 35kV 15kV Range 750 - 1500 25kV Range 600 - 1250 35kV Range 350 - 1000	8454	3M ELECTRICAL PRODUCTS	10
	66910023ELASTIMOLD	Contact, Loadbreak Long Bi-Metal 200A #1 Stranded/Compressed or 1/0 Solid/Compact	02500230	THOMAS & BETTS	1
	66910024ELASTIMOLD	Contact, Loadbreak Long Bi-Metal 200A 1/0 Stranded/Compressed or 2/0 Solid/Compact	02500240	THOMAS & BETTS	1
	66910025ELASTIMOLD	Contact, Loadbreak Long Bi-Metal 200A 3/0 Stranded/Compressed or 4/0 Solid/Compact	02500260	THOMAS & BETTS	1
	66910027ELASTIMOLD	Contact, Loadbreak Long Bi-Metal 200A 4/0 Stranded/Compressed or 250 Solid/Compact	02500270	THOMAS & BETTS	1
	66930005ELASTIMOLD	Elbow Probe, Loadbreak, 15kV 200A	166LRF	THOMAS & BETTS	1

Madison, WI

Mt. Pleasant, MI

Williston, ND

Kearney, NE









Moorhead, MN

Elkhart, IA

Pierre, SD

CABLE ACCESSORIES

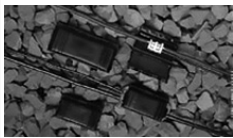
IMAGE	RESCO PART #	DESCRIPTION	MFR MODEL #	MANUFACTURER	PACK. QTY.
	66940141ELASTIMOLD	Bushing Insert, Loadbreak 15kV 200A	1601A4	THOMAS & BETTS	1
	66940141HUBBELL	Bushing Insert, Loadbreak 15kV 200A	215BI	HUBBELL POWER SYSTEMS	25
	66942501ELASTIMOLD	Bushing Insert, Loadbreak 25kV 200A	2701A4	THOMAS & BETTS	1
	66942501HUBBELL	Bushing Insert, Loadbreak 25/28kV 200A	225BI	HUBBELL POWER SYSTEMS	1
	66940134ELASTIMOLD	Insulating Cap Without Ground, Loadbreak 15kV 200A	160DR	THOMAS & BETTS	30
	66940136ELASTIMOLD	Insulating Cap With Ground, Loadbreak 15kV 200A	160DRG	THOMAS & BETTS	1
	66940136HUBBELL	Insulating Cap with Insulated Cuff, Loadbreak 15kV 200A	215ICI	HUBBELL POWER SYSTEMS	1
	66942571ELASTIMOLD	Insulating Cap With Ground Lead and Insulated Cuff, Loadbreak 25kV 200A	273DRG(3)	THOMAS & BETTS	20

IMAGE	RESCO PART #	DESCRIPTION	MFR MODEL #	MANUFACTURER	PACK. QTY.
	66942571HUBBELL	Insulating Cap, Loadbreak 25/28kV 200A	9U01BEW500	HUBBELL POWER SYSTEMS	20
	66940137ELASTIMOLD	Insulated Parking Bushing, Loadbreak 15kV 200A	161SOP	THOMAS & BETTS	1
	66940137HUBBELL	Standoff Bushing, Loadbreak 15kV 200A	215SB	HUBBELL POWER SYSTEMS	1
	66940082ELASTIMOLD	Insulated Parking Bushing, Loadbreak 25kV 200A	272SOP	THOMAS & BETTS	1
	66940142ELASTIMOLD	Feed-Thru Insert, Loadbreak 15kV 200A	1602A3R	THOMAS & BETTS	1
	66940063HUBBELL	Feed-Thru, Horizontal, Loadbreak 15kV 200A	215FT	HUBBELL POWER SYSTEMS	1
	66940064HUBBELL	Feed-Thru, Horizontal, Loadbreak 25/28kV 200A	228FT	HUBBELL POWER SYSTEMS	1
	60100290RAYCHEM	1000V H-Frame Gel Closure, #2 - 2/0 Main, #14 - 6 Tap, 4.25" Length, Overhead or Underground	GHFC-2-90(B100)	TYCO ELECTRONICS	10
	60100058RAYCHEM	GILS In-Line Splice, 1000V, #2 - 4/0 AWG, Water Resistant Gel	GILS-4/0(B18)	TYCO ELECTRONICS	18
	60100250RAYCHEM	1000V GELWRAP Splice Closure, #12 - 4/0, 10" Length	GELWRAP-18/4-250(B6)	TYCO ELECTRONICS	6

Madison, WI

Mt. Pleasant, MI

Williston, ND

Kearney, NE

Moorhead, MN

Elkhart, IA

Pierre, SD

CABLE ACCESSORIES







IMAGE	RESCO PART #	DESCRIPTION	MFR MODEL #	MANUFACTURER	PACK. QTY.
	60100070RAYCHEM	Rayvolve Roll On Splice, 1000V, #8 - 2/0	RVS-11 (B50)	TYCO ELECTRONICS	50
	60100071RAYCHEM	Rayvolve Roll On Splice, 1000V, 1/0 - 250	RVS-12 (B50)	TYCO ELECTRONICS	50
	60100072RAYCHEM	Rayvolve Roll On Splice, 1000V, 250 - 600	RVS-13 (B50)	TYCO ELECTRONICS	50
	60100073RAYCHEM	Rayvolve Roll On Splice, 1000V, 600 - 1000	RVS-14 (B50)	TYCO ELECTRONICS	50
	60712600ELASTIMOLD	15kV Splice 2 SOL 175-220MIL, 0.64" - 0.82"	15PCJ1F1210	THOMAS & BETTS	1
	60712602ELASTIMOLD	15kV Splice 2 STR 175-220MIL, 0.64" - 0.82"	15PCJ1F1220	THOMAS & BETTS	1
	60712604ELASTIMOLD	15kV Splice 1/0 SOL 175-220MIL, 0.64" - 0.82"	15PCJ1F1230	THOMAS & BETTS	1
	60712605ELASTIMOLD	15kV Splice 1/0 SOL 220-260MIL, 0.76" - 0.95"	15PCJ1G1230	THOMAS & BETTS	1
	60712607ELASTIMOLD	15kV Splice 1/0 STR 175-220MIL, 0.76" - 0.95"	15PCJ1G1240	THOMAS & BETTS	1
	60712610ELASTIMOLD	15kV Splice 4/0 STR 175-220MIL, 0.85" - 1.05"	15PCJ1H1270	THOMAS & BETTS	1
	60712618ELASTIMOLD	15kV Splice 4/0 STR 220-260MIL, 0.85" - 1.05"	15PCJ1J1270	THOMAS & BETTS	1
	60712630ELASTIMOLD	15kV Splice 350MCM 220-260MIL, 1.09" - 1.31"	15PCJ1K1300	THOMAS & BETTS	15
	60712633ELASTIMOLD	15kV Splice 500MCM 220-260MIL, 1.18" - 1.465"	15PCJ1L1330	THOMAS & BETTS	15
	60712638ELASTIMOLD	15kV Splice 750MCM 175-260MIL, 1.37" - 1.63"	15PCJ1M1380	THOMAS & BETTS	15
	60712613ELASTIMOLD	25kV Splice 1/0 SOL 260MIL, 0.85" - 1.05"	25PCJ1-H1-230	THOMAS & BETTS	15
	60714899MMM	15kV JCN Rubber Cable Splice 1/0 SOL / 2 STR, 0.637" - .90"; With Connector	5411-CI-21	3M ELECTRICAL PRODUCTS	1
	60714890MMM	15kV JCN Cable Repair Splice 1/0 SOL / 2 STR, 0.637" - .90"; With Connector	5411R-CIR-21	3M ELECTRICAL PRODUCTS	1
	60714897MMM	15kV JCN Rubber Cable Splice 2 SOL, 0.637" - .90"; With Connector	5411-CI-22	3M ELECTRICAL PRODUCTS	1
	60714880MMM	15kV JCN Cable Repair Splice 2 SOL, 0.637" - .90"; With Connector	5411R-CIR-22	3M ELECTRICAL PRODUCTS	1
	60714902MMM	15kV JCN Rubber Cable Splice 4/0 STR, 0.840" - 1.05"; With Connector	5412-CI-4/0	3M ELECTRICAL PRODUCTS	1
	60714896MMM	15kV JCN Cable Repair Splice 4/0 STR, 0.90" - 1.055"; With Connector	5412R-CIR-4/0	3M ELECTRICAL PRODUCTS	1
	60100208RAYCHEM	15kV Heat Shrink Splice Kit, #2 - 2/0, 0.65" - 0.95", No Connector	HVS-C-1511S-J	TYCO ELECTRONICS	1
	60100210RAYCHEM	15kV Heat Shrink Splice Kit, 3/0 - 400, 0.85" - 1.30", No Connector	HVS-C-1512S-J	TYCO ELECTRONICS	1
	60715455MMM	25kV CN or JCN Cable Repair Splice Kit, 2 STR or 1/0 SOL, 0.870" - 1.055"; With Connector	5451R-CIR-21-840	3M ELECTRICAL PRODUCTS	1
	78730211MMM	Splice 1000V 2/0 AWG - 250 kcmil Maximum Connector Length 5" Minimum Cable Diameter for Seal 0.55" Maximum Diameter Insulation Cable or Connector Cover 1.18"	8426-9	3M ELECTRICAL PRODUCTS	10

IMAGE	RESCO PART #	DESCRIPTION	MFR MODEL #	MANUFACTURER	PACK. QTY.
	6010006RAYCHEM	Heat Shrink, 600V Medium Wall Tubing, 48"L, 1.00 - 2.90"	MWTM-85/25-1200-S	TYCO ELECTRONICS	5
	6010008RAYCHEM	Heat Shrink, 600V Medium Wall Tubing, 48"L, 1.40 - 3.90"	MWTM-115/34-1200-S-(B5)	TYCO ELECTRONICS	5
	60100011DSGCANUSA	Heat Shrink, 1000V, Heavy Wall Tubing #14-10, 0.15" - 0.30", 48" Length	CFW-0350-D48	DSG-CANUSA	50
	60100084DSGCANUSA	Heat Shrink, 1000V, Heavy Wall Tubing #1-3/0, 0.40" - 0.95", 9" Length	CFW-0750-D6	DSG-CANUSA	50
	60100012DSGCANUSA	Heat Shrink, 1000V, Heavy Wall Tubing #6-2, 0.25" - 0.65", 48" Length	CFW-0750-D48	DSG-CANUSA	25
	60100085DSGCANUSA	Heat Shrink, 1000V, Heavy Wall Tubing #2 - 500, 0.35" - 1.22", 9" Length	CFW-1100-D9	DSG-CANUSA	50
	60100013DSGCANUSA	Heat Shrink, 1000V, Heavy Wall Tubing #1-3/0, 0.40" - 0.95", 48" Length	CFW-1100-D48	DSG-CANUSA	25
	60100014DSGCANUSA	Heat Shrink, 1000V, Heavy Wall Tubing 250-500, 0.70" - 1.75", 48" Length	CFW-2000-D-48	DSG-CANUSA	25
	60100015DSGCANUSA	Heat Shrink, 1000V, Heavy Wall Tubing 600-1000, 0.95" - 2.30", 48" Length	CFW-2700-D-48	DSG-CANUSA	15
	60100016DSGCANUSA	Heat Shrink, 1000V, Heavy Wall Tubing 800-1250, 1.30" - 3.10", 48" Length	CFW-3500-D-48	DSG-CANUSA	5
	60100012RAYCHEM	Heat Shrink, 1000V, Heavy Wall Tubing 6-4/0, 0.25 - 0.86", 48" Length	WCSM-24/6-1200S	TYCO ELECTRONICS	25
	60100085RAYCHEM	Heat Shrink, 1000V, Heavy Wall Tubing #1-3/0, 0.40" - 0.95", 9" Length	WCSM-34/8-225-S	TYCO ELECTRONICS	50
	60100013RAYCHEM	Heat Shrink, 1000V, Heavy Wall Tubing 2-500, 0.35 - 1.22", 48" Length	WCSM-34/8-1200S	TYCO ELECTRONICS	25
	60100015RAYCHEM	Heat Shrink, 1000V, Heavy Wall Tubing 500-1500, 0.86 - 2.48", 48" Length	WCSM-70/20-1200S	TYCO ELECTRONICS	10
	60100018DSGCANUSA	Heat Shrink Wraparound Cable Repair Sleeve, 1.69" - 0.32", 48" Length	CRDW-1-48	DSG-CANUSA	5
	60100020DSGCANUSA	Heat Shrink Wraparound Cable Repair Sleeve, 2.95" - 0.59", 48" Length	CRDW-2-48	DSG-CANUSA	5
	60100022DSGCANUSA	Heat Shrink Wraparound Cable Repair Sleeve, 3.66" - 0.98", 48" Length	CRDW-3-48	DSG-CANUSA	5
	60100030DSGCANUSA	Heat Shrink Cable End Cap, 300-1000, General Use Diameter 0.45" - 1.20"	CCAP-1300-RL	DSG-CANUSA	40
	60100032DSGCANUSA	Heat Shrink Cable End Cap, 900-2500, General Use Diameter 0.82" - 1.80"	CCAP-2050-RL	DSG-CANUSA	20
	60100065DSGCANUSA	Non-Tracking Red Sealant Strip 2.10" x 15" x 0.04", Medium Voltage Usage	CTSR-021535	DSG-CANUSA	15
	60100122RAYCHEM	High Voltage Busbar Insulating Tape, 25 Foot Roll, 5-15kV	HVBT-2-R-01	TYCO ELECTRONICS	4
	60714929MMM	Heat Shrink Splice Jacket Kit, 15kV, 33" Length, 0.85" - 1.90" Cable Splice O.D.	HSJ-1	3M ELECTRICAL PRODUCTS	10
	60714930MMM	Heat Shrink Splice Jacket Kit, 15kV - 35kV, 40" Length, 1.00" - 2.60" Cable Splice O.D.	HSJ-2	3M ELECTRICAL PRODUCTS	10

Madison, WI

Mt. Pleasant, MI

Williston, ND

Kearney, NE

Moorhead, MN

Elkhart, IA

Pierre, SD

CABLE ACCESSORIES



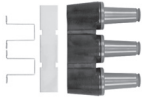



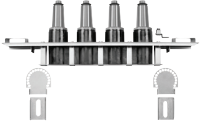

IMAGE	RESCO PART #	DESCRIPTION	MFR MODEL #	MANUFACTURER	PACK. QTY.
	60714924MMM	Cold Shrink Splice Jacket Kit, 15kV, 28" Length, 0.95" - 2.40" Cable Splice O.D.	SJ-1A	3M ELECTRICAL PRODUCTS	6
	60714925MMM	Cold Shrink Splice Jacket Kit, 15kV - 35kV, 36" Length, 1.15" - 3.30" Cable Splice O.D.	SJ-2A	3M ELECTRICAL PRODUCTS	6
	60714926MMM	Cold Shrink Splice Jacket Kit, 15kV - 35kV, 38" Length, 1.55" - 4.00" Cable Splice O.D.	SJ-3A	3M ELECTRICAL PRODUCTS	6
	66940116HUBBELL	Junction, Loadbreak, 2 Point 15kV 200A, With U-Straps	215J2U	HUBBELL POWER SYSTEMS	1
	66940110HUBBELL	Junction, Loadbreak, 3 Point 15kV 200A, With U-Straps	215J3U	HUBBELL POWER SYSTEMS	1
	66940110ELASTIMOLD	Junction, Loadbreak, 3 Point 15kV 200A, With U-Straps	164J3-5	THOMAS & BETTS	1
	66940114HUBBELL	Junction, Loadbreak, 4 Point 15kV 200A, With U-Straps	215J4U	HUBBELL POWER SYSTEMS	1
	66940114ELASTIMOLD	Junction, Loadbreak, 4 Point 15kV 200A, With U-Straps	164J4-5	THOMAS & BETTS	1
	66942535HUBBELL	Junction, Loadbreak, 3 Point 25/28kV 200A, With U-Straps	228J3U (9U07BHF300)	HUBBELL POWER SYSTEMS	1
	66942514HUBBELL	Junction, Loadbreak, 4 Point 25/28kV 200A, With U-Straps	228J4U (9U07BHF400)	HUBBELL POWER SYSTEMS	1
	66942514ELASTIMOLD	Junction, Loadbreak, 4 Point 25kV 200A, With U-Straps	274J4(1)-5	THOMAS & BETTS	1
	66890202ELASTIMOLD	Junction, Deadbreak, 3 Point 15/25kV 600A, With U-Straps	K650J3-5	THOMAS & BETTS	1
	66890200ELASTIMOLD	Junction, Deadbreak, 4 Point 15/25kV 600A, With U-Straps	K650J4-5	THOMAS & BETTS	1

IMAGE	RESCO PART #	DESCRIPTION	MFR MODEL #	MANUFACTURER	PACK. QTY.
	66890211ELASTIMOLD	Junction, Deadbreak, 4 Point 15/25KV 600A, With Stainless Steel Mounting Plate, Back Plate, Adjustable Mounting Bracket	K650J4-U	THOMAS & BETTS	1
	66890213ELASTIMOLD	Junction, 4 Point, 25kv, Right Parking Stand. Includes 2 each 200A Deepwell Interface and 2 each 600A Bushing Interface	J4-6226-25R	THOMAS & BETTS	1
	66890212ELASTIMOLD	Mounting Bracket and Back Plate for K650 Deadbreak Junction	K650-J4-6	THOMAS & BETTS	1
	66940048OHIOBRASS	Elbow Arrester 3KV 2.55MCOV 15KV Class	215ELA03	HUBBELL POWER SYSTEMS	1
	66940050OHIOBRASS	Elbow Arrester 10KV 8.4MCOV 15KV Class	215ELA10	HUBBELL POWER SYSTEMS	1
	66942510OHIOBRASS	Elbow Arrester 10KV 8.4MCOV 25KV Class	225ELA10	HUBBELL POWER SYSTEMS	1
	66940054ELASTIMOLD	Elbow Arrester 10KV 8.4MCOV 25KV Class	273ESA-10	THOMAS & BETTS	1
	66940055OHIOBRASS	Elbow Arrester 18KV 15.3MCOV 25KV Class	225ELA18	HUBBELL POWER SYSTEMS	1
	66940055ELASTIMOLD	Elbow Arrester 18KV 15.3 MCOV 25KV Class	273ESA-18	THOMAS & BETTS	1
	66940059HUBBELL	Parking Stand Arrester 10KV 8.4 MCOV 15kv Class	215PLA-10	HUBBELL POWER SYSTEMS	1
	66940059ELASTIMOLD	Parking Stand Arrester 10kv 8.4 MCOV 15kv Class	167PSA-10	THOMAS & BETTS	1
	66940125DSGCANUSA	Mid-Span External Ground Kit, 15-35KV 15kv 250-1000kcmil 25kv 1/0-750kcmil 35kv 1/0-500kcmil	CJGK-2	DSG-CANUSA	1

Madison, WI

Mt. Pleasant, MI

Williston, ND



Kearney, NE

Moorhead, MN

Elkhart, IA

Pierre, SD

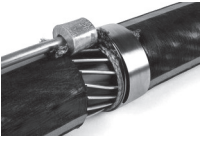
CABLE ACCESSORIES

IMAGE	RESCO PART #	DESCRIPTION	MFR MODEL #	MANUFACTURER	PACK. QTY.
	60712252MMM	Cable Ground Kit, #2 - 4/0 Jacketed Concentric Neutral, Rated up to 35KV	2252	3M ELECTRICAL PRODUCTS	1
	66940139ELASTIMOLD	Inline Ground Connector for Jacketed Cable Neutrals or Metallic Shields	PCG-1	THOMAS & BETTS	1

CORPORATE – WISCONSIN

Office/Warehouse

2250 Pinehurst Drive
Middleton, WI 53562

Sales Support: (800) 356-9370

MINNESOTA

Office/Warehouse

4100 30th Avenue South
Moorhead, MN 56560

Sales Support: (800) 346-3330

IOWA

Office/Warehouse

1308 NW Laurel Street
Elkhart, IA 50073

Sales Support: (888) 293-7372

MICHIGAN

Warehouse

1640 Gover Parkway
Mt. Pleasant, MI 48858

Sales Support: (800) 356-9370

NORTH DAKOTA

Warehouse

508 58th Street West
Williston, ND 58801

Sales Support: (800) 346-3330

SOUTH DAKOTA

Warehouse

3715 Airport Road
Pierre, SD 57501

Sales Support: (800) 346-3330

NEBRASKA

Warehouse

404 West 8th Street
Suite 2

Kearney, NE 68845

Sales Support: (888) 293-7372

info@resco1.com

www.resco1.com

STORM RESPONSE

(866) 273-5030

The logo for RESCO, featuring the word "RESCO" in a bold, red, sans-serif font. A stylized lightning bolt icon is integrated into the letter "R".